

JMA®



SUPLEMENTO-SUPPLEMENT

LLAVES + ESPECIALISTA - KEYS + SPECIALIST

C11.2018

www.jma.es

A2 JMA es Compromiso

JMA Konpromisoa da
JMA is Commitment
JMA, l'engagement
JMA bedeutet Verpflichtung

A3 Multicode

Multicode
Multicode
Multicode
Multicode

A4-A5 Aviso Legal

Mezu Legala
Legal Warning
Informations Légales
Rechtliche Hinweise

A6-A7 Descripción y Terminología

Deskribapen eta Terminologia
Description and Terminology
Description et Terminologie
Begriffserklärung und Terminologie

A8-A9 Símbolos y Nacionalidades

Ikur eta Nazionalitateak
Symbols and Nationalities
Symboles et Nationalités
Symbole und Nationalitäten

A11-A14 ÍNDICES
AURKIBIDEA
INDEX
INDEX
GESAMTVERZEICHNIS

A11 Índice General

Aurkibidea
General Index
Index Generale
Gesamtverzeichnis

A14 Índice de Marcas

Marken Aurkibidea
Brand Index
Index Marque
Hauptmarke

1-30 LLAVES
GILTZAK
KEYS
CLÉS
SCHLÜSSEL

1 - 30 Imágenes de Llaves

Giltzen Irudiak
Keys Images
Images Clés
Schlüssel Bilder

B1 - B7 CAT. ESPECIALISTA DE MÁQUINAS DUPLICADORAS
KOPIATZEKO MAKINEN GIDA ESPEZIALISTA
KEY CUTTING SPECIALIST'S GUIDE
SPÉCIALISTE CATALOGUE DE MACHINES DUPLICATRICES
SPEZIALISTKATALOG

NUESTRO ÉXITO ESTÁ BASADO EN EL COMPROMISO DE LAS PERSONAS**OUR SUCCESS IS BASED ON OUR PEOPLE'S COMMITMENT**

Alejandro Altuna S.L.U es la sociedad matriz e impulsora de Altuna Group. Fabrica todo tipo de llaves para cerradura así como máquinas duplicadoras. Sus productos van destinados al mercado OEM y a la reposición, en este caso con la marca JMA.

Alejandro Altuna S.L.U. is the parent company and driving force behind the Altuna Group. It manufactures all types of lock-keys and key-cutting machines. Its products are for the OEM and replacement markets, in the latter case with the JMA brand.

Fundada por el Sr. Alejandro Altuna en 1942 arrancó su actividad en Mondragón. Posteriormente, la estrategia de apertura de mercados exteriores apoyada en la internacionalización y siempre basada en un enfoque innovador de los procesos industriales, ha convertido a ALTUNA GROUP en el primer productor de llaves europeo y referente mundial en este campo.

Set up by Alejandro Altuna in 1942, it started the production in Mondragón (Spain). Later, the strategy of opening up to foreign markets backed by globalisation and always based on an innovative attitude towards industrial processes, turned the ALTUNA GROUP into the largest producer of keys in Europe and a benchmark worldwide in the field.

Actualmente, 15 compañías en 4 continentes trabajan conjuntamente para el desarrollo y potenciación de la fuerza de nuestra marca JMA, conocida en más de 100 países en todo el mundo.

Currently 15 companies in four continents work together to develop the strength of our JMA brand, well known in more than 100 countries all over the world.

JMA integra equipos de personas comprometidas y motivadas por un proyecto común que nos ha permitido ser el mayor fabricante de llaves de Europa.

This successful trail that led us to be the biggest key producer in Europe is based in our people's commitment to be:

LIDER EN TECNOLOGÍA:

Una apuesta sólida por la calidad y la innovación basada en la automatización y garantía de procesos y soportada por una vocación inversora a largo plazo.

**THE LEADER IN TECHNOLOGY,**

looking for the latest developments to improve the production processes together with a strong investment policy in all our plants to ensure the company's competitiveness and long-term future.

LIDER EN CALIDAD:

Nuestra política de calidad se basa en la prevención y planificación, mejora continua, satisfacción del cliente y participación de las personas. Además de la Certificación en Calidad de acuerdo a la ISO 9001, Alejandro Altuna S.L.U. acoge Sistemas de Gestión de la Calidad homologados por las empresas líderes del sector de automoción y residencial.

**THE LEADER IN QUALITY:**

Our quality policy is based on prevention and planning, continuous improvement, customer satisfaction and people participation. In addition to Quality Certification to ISO 9001, Alejandro Altuna S.L.U. operates Quality Management Systems approved by the leading companies in the automotive and residential sectors.

LIDER EN EL COMPROMISO POR EL MEDIO AMBIENTE:

En Alejandro Altuna S.L.U. las buenas prácticas medioambientales son la norma y no la excepción. Nuestro equipo forma parte de un proyecto de empresa respetuoso con el medioambiente y que colabora con el desarrollo sostenible de nuestro entorno. Alejandro Altuna S.L.U. fue el primer fabricante mundial de llaves en conseguir en 2000 el certificado ISO 14001 para su Sistema de Gestión.

**THE LEADER IN THE COMMITMENT TO THE ENVIRONMENT:**

At Alejandro Altuna S.L.U. best environmental practice is the norm and not the exception. Our team is part of a business project that respects the environment and contributes to the sustainable development of our community. Alejandro Altuna S.L.U. was the first key manufacturer in the world to achieve ISO 14001 certification for its management system in 2000.

LIDER EN SERVICIO:

La realidad de una empresa se demuestra en su capacidad por responder con la máxima celeridad y eficacia a las necesidades y exigencias de los clientes. Se encuentren donde se encuentren. Además, gracias a su amplia red de filiales y empresas distribuidoras repartidas por todo el mundo, le permite llegar a cualquier cliente, se cual sea su ubicación.

**THE LEADER IN SERVICE,**

The efficiency of a company is shown in its capacity to respond with the maximum speed and effectiveness to the needs and requirements of its customers, wherever they are based. Moreover, with its extensive network of associate and distribution companies located throughout the world, the company can reach any customer, wherever based.

NUEVO PRODUCTO - MULTICODE

NEW PRODUCT - MULTICODE

LA SOLUCIÓN 'TODO EN UNO' RÁPIDA Y COMPACTA
Copia llaves planas, de seguridad y automoción

THE FAST AND COMPACT ALL-IN-ONE SOLUTION
Copies flat, security and vehicle keys



NUEVA TECNOLOGÍA
NEW TECHNOLOGY



MULTIFUNCIONALIDAD
MULTIFUNCTIONALITY



Con la nueva **MULTICODE**, JMA le ofrece la solución profesional 'todo en uno' para su negocio. Su multifuncionalidad **le permite copiar llaves planas, de seguridad y de automoción sin cambiar de máquina**. Conozca su potencia y rapidez para mecanizar llaves de una sola pasada y descubra su última tecnología, que incorpora una tablet y la **APP JMAKEYPRO** para facilitarle el duplicado de todo el catálogo JMA y sus equivalencias.

With the new **MULTICODE**, JMA offers an all-in-one professional solution for your business. Its multi-functional nature means it can **cut to code and copy flat, security and vehicle keys without needing to switch machines**. Witness its power and speed for cutting keys in a single motion and discover its cutting-edge technology, which uses a tablet and the **JMAKEYPRO app** for duplicating the entire catalogue of JMA keys and their equivalents.

ESPAÑOL

AVISO LEGAL - SUPLEMENTO C11.2018

Las llaves que aparecen en este catálogo son piezas JMA fabricadas por JMA Alejandro Altuna S.L.U. o un subcontratista de éste. Están diseñadas para cilindros y cerraduras de los fabricantes cuyas marcas se indican en este catálogo.

Conforme a las disposiciones legales vigentes relativas a la propiedad industrial, las marcas o nombres comerciales indicados en este catálogo son propiedad exclusiva de los fabricantes de cilindros y cerraduras, así como de los fabricantes de automóviles, otros constructores, distribuidores y usuarios.

Dichas marcas o nombres comerciales se indican en calidad simplemente informativa con el fin de reco-

nocer con rapidez la cerradura a la que corresponden nuestras piezas.

Este catálogo está reservado exclusivamente a profesionales de la reproducción de llaves que utilizan piezas JMA.

Los datos referentes a los productos de este catálogo tienen carácter indicativo. Manteniendo siempre las características básicas, nos reservamos el derecho de realizar, sin previo aviso, modificaciones técnicas, estéticas o de otro tipo, por razones de evolución de los productos en cuestión.

Algunos modelos que están en este nuevo catálogo podrán recibirlos tanto con la marca y la referencia JMA como con otra marca del grupo ALTUNA.

EUSKERA

LEGE-OHARRA - C11.2018 SUPLEMENTO A

Katalogo honetan ageri diren giltzak Alejandro ALTUNA SLU enpresak edo honek kontratatutako beste enpresabatekin dako JMA piezak dira. Katalogoan zehazten diren marken fabrikatzaileen zilindro eta sarrailetarako diseinatuta daude.

Jabetza industrialari buruz indarrean dauden lege-xedapenekin bat etorri, katalogo honetan zehaztutako merkataritza-markak edo izenak zilindro eta sarraileen fabrikatzaileen nahiz ibilgailuen fabrikatzaileen eta beste erakitzailen, banatzaile eta erabiltzaile batzuen jabetza eskusibokoak dira.

Merkataritza-marka edo izen horiek zehaztasun gehiago emateko adierazten dira, gure piezak zein sarraileri dagozkion berehala ikusi ahal izateko.

Katalogo hau giltzen kopiari egiteko JMA piezak erabiltzen dituzten profesionalentzako da soilik.

Katalogo honetako produktuei buruzko datuek izaera adierazgarria dute. Oinarriko ezaugarriak gordez, produktuen bilakaeraren ondoriozko aldaketak teknikoak, estetikoak edo bestelakoak egiteko eskubidea dugu, aurretik horren berri eman beharrik gabe.

Katalogo berri honetan dauden eredueta batak JMA marka eta erreferentziarekin nahiz ALTUNA taldeko beste marka batekin jaso ahal izango dira.

ENGLISH

LEGAL WARNING - SUPPLEMENT C11.2018

The keys that appear in this catalogue are JMA parts manufactured by JMA Alejandro Altuna S.L.U. or one of its subcontractors. They are designed for cylinders and locks made by the manufacturers whose trademarks are indicated in this catalogue.

In accordance with legal requirements relating to industrial property rights, the trademarks or trade names indicated in this catalogue are the exclusive property of the manufacturers of the cylinders and locks, as well as automobile manufacturers, other constructors, distributors and users.

The aforementioned trademarks or trade names are indicated simply for information purposes so that the lock to which our parts correspond can be recognised quickly and easily. This catalogue is for the exclusive use of professional key copiers who use JMA parts.

Data referring to the products in this catalogue are indicative in nature. Although the basic characteristics are maintained at all times, we reserve the right to make, without previous notice, any technical, aesthetic or other types of changes involved in the development of the products in question. Some of the keys in this new catalogue could be received either with the JMA reference and trademark or with another trademark from the ALTUNA group.

FRANÇAIS

MENTIONS LEGALES - SUPPLEMENT C11.2018

Les ébauches de clés reportées sur ce catalogue sont des ébauches JMA fabriquées par JMA Alejandro Altuna S.L.U. ou un de ses sous-traitants. Elles sont destinées aux cylindres et serrures des fabricants dont les marques sont indiquées dans ce catalogue.

Conformément aux dispositions légales en vigueur relatives à la propriété industrielle, les marques ou les dénominations commerciales citées dans ce catalogue sont la propriété exclusive des fabricants de cylindres et de serrures ainsi que des constructeurs de voitures, autres constructeurs, distributeurs et utilisateurs.

Ces marques ou dénominations commerciales sont indiquées à titre de simple information afin de connaître rapidement à quelle serrure nos ébauches sont destinées.

Ce catalogue est exclusivement réservé aux professionnels de la reproduction de clés, utilisant des ébauches JMA.

Les renseignements sur les produits de ce catalogue sont donnés à titre indicatif. Tout en gardant les caractéristiques de base, nous nous réservons le droit d'apporter, sans préavis, des modifications techniques, esthétiques ou autres, dues à l'évolution des produits en question.

Des ébauches de ce catalogue pourront être livrées soit avec la marque et référence JMA soit avec une autre marque du groupe ALTUNA.

DEUTSCH

RECHTSHINWEIS- NACHTRAG C11.2018

Die in dem vorliegenden Katalog aufgeführten Schlüssel sind JMA-Teile, die von der Firma Alejandro ALTUNA, S.L.U., einem Zulieferanten von JMA, hergestellt werden. Sie sind für Zylinder und Schlösser derjenigen Hersteller entwickelt worden, deren Marken in diesem Katalog aufgeführt sind.

In Übereinstimmung mit den geltenden gesetzlichen Vorschriften bezüglich des gewerblichen Eigentums sind die im vorliegenden Katalog aufgeführten Marken und Firmennamen ausschließliches Eigentum der Zylinder- und Schloßhersteller, sowie der Automobilhersteller und anderer Konstrukteure, Vertrieber und Benutzer.

Diese Marken und Firmennamen werden nur zu Informationszwecken aufgeführt, mit dem Ziel, auf schnelle Weise zu erkennen, zu welchem Schloß unsere Teile gehören.

Dieser Katalog ist ausschließlich für Fachleute des Bereichs der Schlüsselreproduktion gedacht, die JMA-Teile verwenden.

Die Daten bezüglich der Produkte des vorliegenden Katalogs haben informativen Charakter. Bei Aufrechterhaltung der grundlegenden Eigenschaften behalten wir uns das Recht vor, aus Gründen der Entwicklung der entsprechenden Produkte und ohne Vorankündigung technische, ästhetische oder andere Änderungen vorzunehmen. Einige Modelle des neuen Katalogs können Sie sowohl mit der Marke und der Bezeichnung JMA erhalten, als auch mit jeder anderen Marke der Gruppe ALTUNA.

THE KEY TO EXCELLENCE

GLOBALLY UNLOCKING MILLIONS OF DOORS DAILY



MANUAL DE USO

MANUAL OF USE

ESPAÑOL

MANUAL DE USO

Todas las llaves del catálogo están en escala 1:1; tanto la silueta como el perfil, para hacer una búsqueda más fácil y precisa. Pasos a seguir para la identificación de la llave:

1. Identificación de la silueta: Confirmar que la llave que busca coincide con las dimensiones de la llave catálogo. Ver Fig. 1

2. Identificación del perfil:

2.1 Ver si el perfil de la llave y el perfil del catálogo forman una misma imagen. Ver Fig. 2.1

2.2 Cerciorar que el perfil del catálogo tiene la misma forma y dimensión, colocando la llave física sobre la imagen del catálogo. Ver Fig. 2.2

EUSKERA

ERABILERA-ESKULIBURUA:

Katalogoko giltza guztiak 1:1 eskalan agertzen dira; hala silueta nola profila, bilaketa errazagoa eta zehatzagoa izan dadin. Giltza identifikatzeko urratsak:

1. Silueta identifikatzea: Bilatzen den giltzak katalogoan agertzen den giltzaren dimentsio bera duela baieztatu. Ikus 1. irudia.

2. Profila identifikatzea:

2.1. Giltzaren profilak eta katalogoko profilak irudi bera osatzen duten ikusi. Ikus 2.1. irudia.

2.2. Katalogoko profilak forma eta dimentsio bera duela ziurtatzea, giltza fisikoa katalogoko irudiaren gainean jarri. Ikus 2.2. irudia.

ENGLISH

MANUAL OF USE

All the keys in this catalogue are 1:1 scale; both the silhouette outline and profile, to facilitate a precise search. Steps to follow for identifying the key:

1. Identification of the silhouette: Confirm that the key you want matches with the dimensions of the key in the catalogue. See Fig. 1

2. Identification of the profile:

2.1. Check to see if the profile of the original key and the profile in the catalogue have a similar shape. See Fig. 2

2.2. Make sure the profile of the catalogue has the same shape and dimension, by placing the physical key over the image in the catalogue. See Fig. 2.2

FRANÇAIS

MANUEL D'UTILISATION

Toutes les clés du catalogue sont à l'échelle 1:1; aussi bien la silhouette que le profil, afin de permettre une recherche plus simple et précise. Étapes à suivre pour l'identification de la clé :

1. Identification de la silhouette : Confirmer que la clé recherchée correspond aux dimensions de la clé du catalogue. Voir Fig.1

2. Identification du profil :

2.1. Voir si le profil de la clé correspond au profil du catalogue. Voir Fig.2.1

2.2. S'assurer que le profil du catalogue a la même forme et les mêmes dimensions, en plaçant la clé physique sur l'image du catalogue. Voir Fig.2.2

DEUTSCH

HANDBUCH

Alle Schlüssel im Katalog sind im Maßstab 1:1 dargestellt, sowohl als Silhouette als auch im Profil, um die Suche leichter und genauer zu machen. Zu befolgende Schritte für die Identifizierung des Schlüssels:

1. Identifizierung der Silhouette: Bestätigung, dass der gesuchte Schlüssel mit dem Abmessungen im Katalog übereinstimmt. Siehe Abb. 1

2. Identifizierung des Profils:

2.1. Prüfen, ob das Profil des Schlüssels und das im Katalog gezeigte Profil übereinstimmen. Siehe Abb. 2.1

2.2. Vergewissern, dass das Profil im Katalog die gleiche Form und Größe hat, indem man den tatsächlichen Schlüssel auf das Katalogbild legt. Siehe Abb. 2.2

IDENTIFICACIÓN DE LA LLAVE

KEY IDENTIFICATION

1. Identificación de la Silueta

Silhouette identification

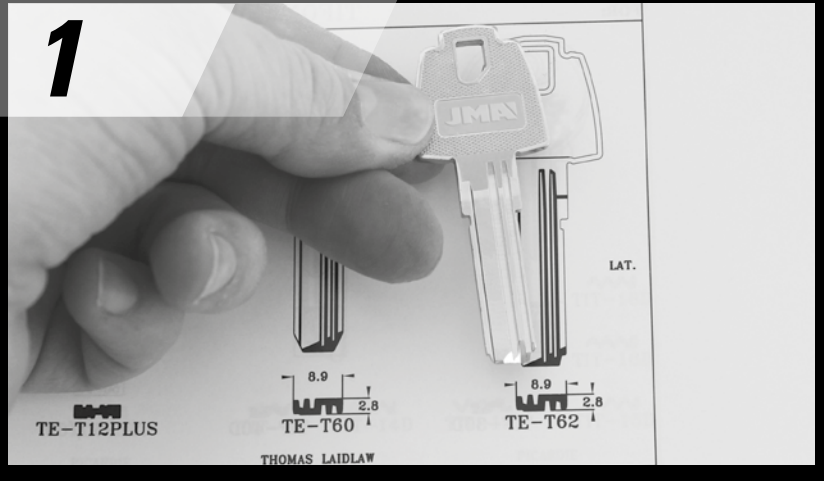

2. Identificación del perfil

Identification of the profile

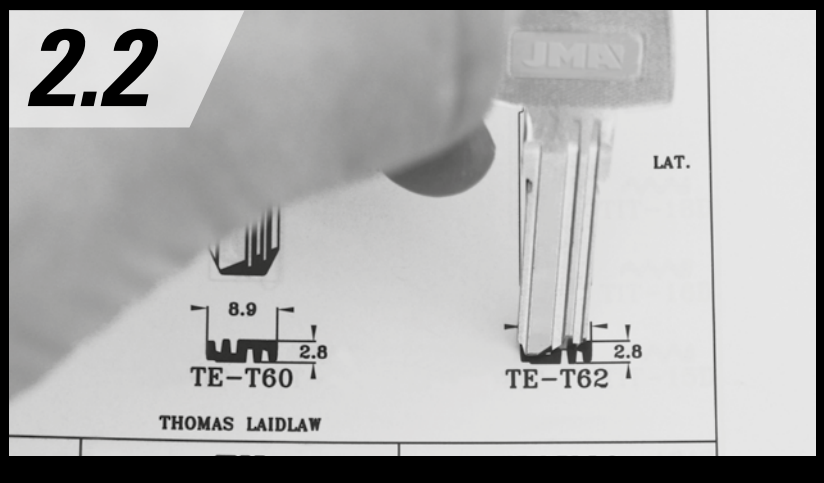

ESPAÑOL

- 1 — MARCA PRINCIPAL
- 2 — CABEZA
- 3 — CUELLO
- 4 — TOPE
- 5 — PALETÓN
- 6 — PUNTA
- 7 — UTILIZACIÓN
- 8 — NOMENCLATURA DE PERFIL ORIGINAL
- 9 — PERFIL IZQUIERDO
- 10 — PERFIL DERECHO
- 11 — REFERENCIA
- 12 — MARCAS SECUNDARIAS
- 13 — SERIES
- 14 — MARCA PRINCIPAL DE LA PRINCIPAL (ABSA)
- 15 — MARCAS SECUNDARIAS DE LA PRINCIPAL (ABSA)

1 — ABSA

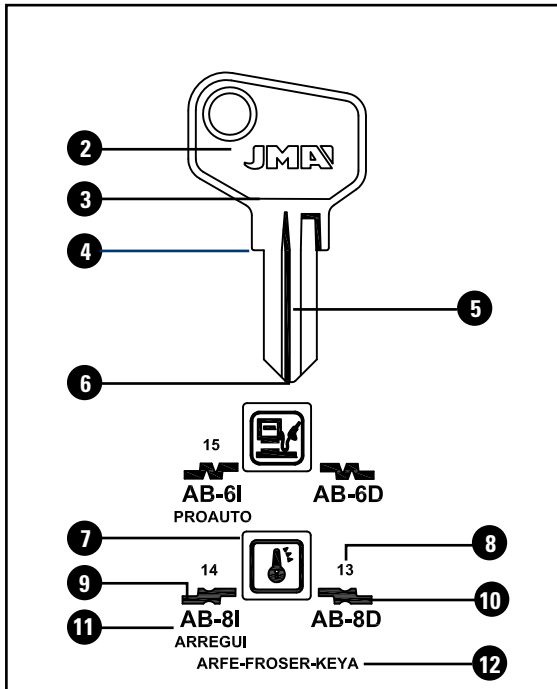

1 — VACHETTE

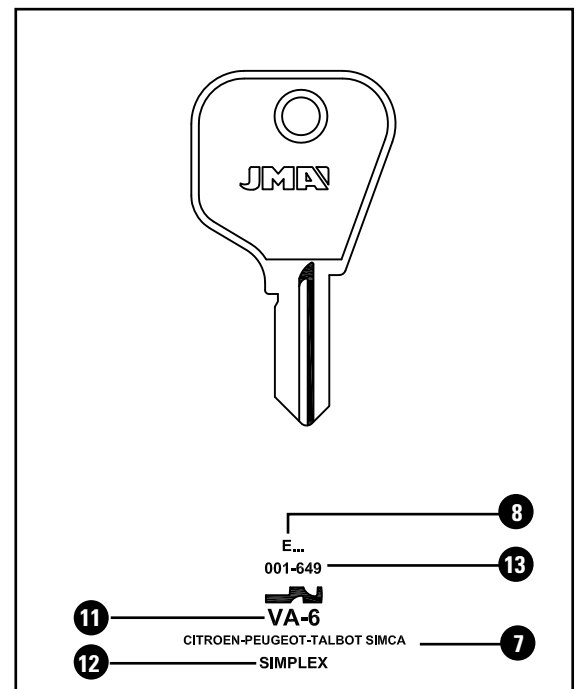

EUSKERA	ENGLISH	FRANÇAIS	DEUTSCH
1 MARKA NAGUSIA	1 MAIN BRAND	1 MARQUE PRINCIPALE	1 HAUPTPRÄGUNG
2 BURUA	2 HEAD	2 TÊTE	2 KOPF
3 LEPOA	3 NECK	3 COU	3 HALS
4 TOPEA	4 SHOULDER	4 ARRÊT	4 ANSCHLAG
5 BELARRIA	5 BLADE	5 CANON	5 SCHAFT
6 PUNTA	6 TIP	6 POINTE	6 SPITZE
7 ERABILERA	7 USE	7 UTILISATION	7 VERWENDUNG
8 JATORRIZKO PROFILAREN IZENDEGIA	8 ORIGINAL PROFILE	8 PROFIL ORIGINAL	8 ORIGINALPROFIL
9 EZKERREKO PROFILA	9 LEFT PROFILE	9 PROFIL GAUCHE	9 LINKSPROFIL
10 ESKUINEKO PROFILA	10 RIGHT PROFILE	10 PROFIL DROIT	10 RECHTSPROFIL
11 ERREFERENTZIA	11 REFERENCE	11 RÉFÉRENCE	11 BEZEICHNUNG
12 BIGARREN MAILAKO MARKAK	12 SECONDARY BRAND	12 MARQUE SECONDAIRE	12 2. PRÄGUNG
13 SERIEAK	13 SERIES	13 CODE	13 SERIE
14 MARCA NAGUSIA ETA JATORRIZKOA	14 MAIN BRAND AND NATIONALITY	14 MARQUE PRINCIPALE ET NATIONALITÉ	14 HAUPTPRÄGUNG UND NATIONALITÄT
15 MARKA NAGUSIAREN BIGARREN MAILAKO MARKAK (ABSA)	15 SECONDARY BRANDS OF THE MAIN ONE (ABSA)	15 MARQUES SECONDAIRES DE LA PRINCIPALE (ABSA)	15 2. PRÄGUNG FÜR HAUPTPRÄGUNG (ABSA)

DESCRIPCIÓN Y TERMINOLOGÍA

KEY DESCRIPTION AND TERMINOLOGY

ESPAÑOL

- 1 CABEZA
- 2 CUELLO
- 3 DIÁMETRO DE LA CAÑA
- 4 CAÑA
- 5 LONGITUD A
- 6 PALETON
- 7 PERFIL MACHO
- 8 REFERENCIA
- 9 MARCA ORIGINAL
- 10 PERFIL HEMBRA

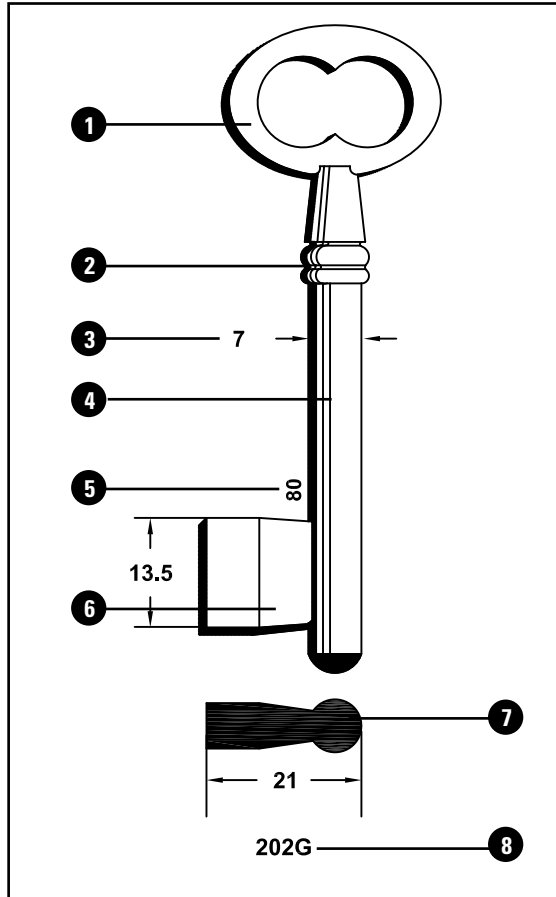

9 — ORENGO

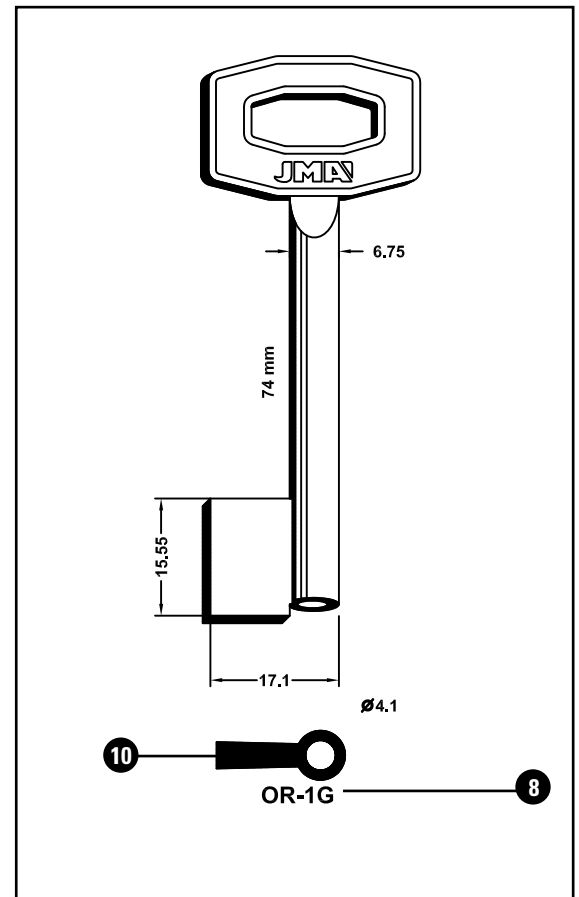

EUSKERA

- 1 BURUA
- 2 LEPOA
- 3 ZIRIAREN DIAMETROA
- 4 ZIRIA
- 5 A LUZERA
- 6 BELARRIA
- 7 PROFIL ARRA
- 8 ERREFERENTZIA
- 9 JATORRIZKO MARKA
- 10 PROFIL EMEA

ENGLISH

- 1 HEAD
- 2 NECK
- 3 SHANK DIAMETER
- 4 SHANK
- 5 LENGTH A
- 6 BIT
- 7 PIN BIT PROFILE
- 8 REFERENCE
- 9 ORIGINAL BRAND
- 10 PIPE BIT PROFILE

FRANÇAIS

- 1 TÊTE
- 2 COU
- 3 DIAMETRE DU CANON
- 4 CANON
- 5 LONGUEUR A
- 6 PANNETON
- 7 PROFIL MÂLE
- 8 RÉFÉRENCE
- 9 MARQUE ORIGINALE
- 10 PROFIL FEMELLE

DEUTSCH

- 1 KOPF
- 2 HALS
- 3 HALM-DURCHMESSER
- 4 HALM
- 5 LÄNGE A
- 6 BART
- 7 SCHWEIFUNG
- 8 BEZEICHNUNG
- 9 ORIGINAL-PRÄGUNG
- 10 GEBOHRT

ALP.

Llave fabricada en alpaca

Alpakaz egindako giltza
Key available in nickel silver
Clé fabriquée en maillechort
Schlüssel auch in Neusilber lieferbar

LAT.

Llave disponible también en latón

Giltza, letoizkoa ere eskuragarria
Key also available in brass
Clé aussi disponible en laiton
Schlüssel auch in Messing lieferbar

COL.

Llave disponible también con cabeza de plástico en colores

Giltza hau koloretako plastikozko buruarekin ere eskuragarria

Key also available with coloured plastic head

Clé aussi disponible avec tête plastifiée en couleurs

Schlüssel auch mit farbigem Plastikkopf lieferbar

ALU.

Llave disponible también en aluminio

Giltza, aluminioan ere eskuragarria
Key also available in aluminium
Clé aussi disponible en aluminium
Schlüssel auch in Aluminium lieferbar

ZAM.

Llave fabricada solamente en zamak

Zamakez soilik egindako giltza
Key only available in zamak
Clé aussi disponible en zamak
Schlüssel nur aus Zamak lieferbar



Llave de utilización en candados

Giltzarrapoetan erabiltzeko giltzak
Key for padlocks
Clé pour cadenas
Schlüssel für Hangschlösser



Llave de utilización en cerraduras auxiliar

Sarraila osagarrietan erabiltzeko giltzak
Key for cam locks
Clé pour petite serrurie
Schlüssel für Hebelschlösser



Llaves para motocicletas

Motozikleta giltzak
Key for motorcycles
Clé pour motocyclettes
Schlüssel für Motorräder



Llave para tapón de gasolina

Gasolina-tapoietarako giltza
Key for fuel cap
Clé pour bouchon d'essence
Schlüssel für Tankdeckel



Llave para camión

Kamioiko giltza
Key for lorries
Clé pour camion
Schlüssel für Lastkraftwagen



Alarma

Alarma
Alarm
Alarme
Alarm



Llaves gorja con acabado en color natural

Gorja giltzak berezko kolorezko akaberarekin
Bit key blank with natural colour finishing
Clé à gorges avec finition en couleur naturel
Chubbsschlüssel in naturfarben Ausführung



Llaves gorja con acabado en negro antiguo

Gorja giltza, beltz zaharkitu akaberarekin
Bit key blank with old black finishing
Clé à gorges avec finition en vieux noir
Chubbsschlüssel in altschwarzer Ausführung

NACIONALIDAD - NAZIONALITATEA - NATIONALITY - NACIONALITÉ - NATIONALITÄT

AUSTRIA
AUSTRALIA
BELGIUM
BRAZIL
CANADA
SWITZERLAND
GERMANY
DENMARK

A
AUS
B
BR
CDN
CH
D
DK

ALGERIA
SPAIN
ESLOVAKIA
EGYPT
FRANCE
GREAT BRITAIN
GREECE
HUNGARY

DZ
E
ES
ET
F
GB
GR
H

HONG KONG
CROATIA
ITALY
ISRAEL
INDIA
EIRE
JAPAN
KOREA

HK
HR
I
IL
IND
IRL
J
K

SÍMBOLOS

SYMBOLS

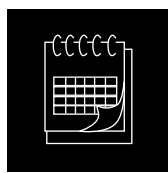

Calendario

Egutegia
Calendar
Calendrier
Kalender

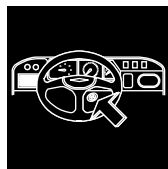

Contacto auto

Autoko kontaktua
Engine ignition
Contact auto
Zündschloss Pkw

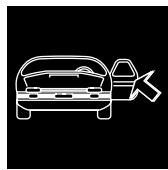

Puerta

Atea
Door lock
Portière
Türe

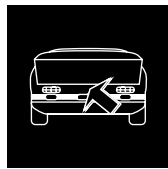

Maletero/Puerta trasera

Maletategia/Atzeko atea
Boot/Hatchback
Coffre/Portière postérieure
Kofferraum/Hecktür



Tapón de gasolina

Gasolina-tapoia
Petrol cap
Bouchon réservoir
Benzintankverschluss

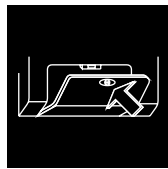

Guantera

Eskularru-kutxa
Drawer
Tiroir
Schublade

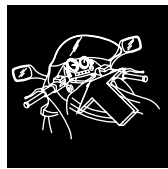

Contacto moto

Moto-kontaktua
Motorbike ignition
Contact moto
Zündschloss Motorrad

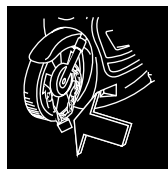

Bloqueo moto

Moto-blokeoa
Motorbike disc lock
Bloquage moto
Bremsenschloss Motorrad



Sillin

Zela
Cycle seat
Selle
Sattel



Casco

Kaskoa
Helmet
Casque
Helm

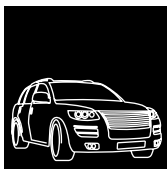

Automovil / camioneta

Automobila / kamioneta
Car / Pick-up trucks
Voiture / Camionnette
Auto / Kleintransporter

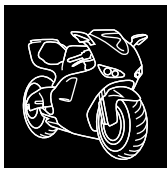

Motocicleta

Motozikleta
Motorcycle
Motocyclette
Motorrad



Camión

Kamioia
Trucks
Camion
Lkw

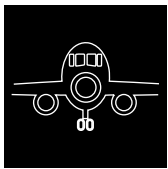

Avión

Hegazkina
Aeroplane
Avion
Flugzeuge

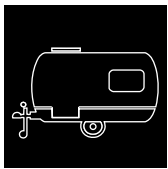

Caravana

Karabana
Caravans
Caravane
Wohnwagen

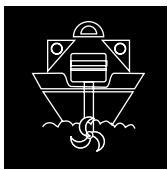

Motor marino

Itsas motorra
Boat engines
Moteur de bateau
Schiffsmotoren

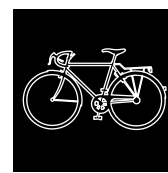

Bicicleta

Bizikleta
Bicycle
Bicyclette
Fahrräder

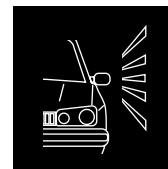

Alarma

Alarma
Alarm
Alarme
Alarm

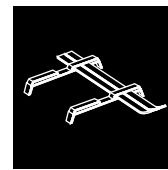

Portaesquis

Eski-euskarria
Ski holder
Porte ski
Skiträger

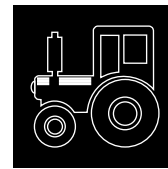

Tractor

Traktorea
Tractor
Traktor
Landmaschinen

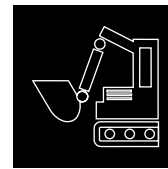

Escavadora

Hondeatzailea
Earth moving machine
Machine déplacement de terre
Baumaschinen



Carretilla elevadora

Orga jasotzailea
Forklift
Clark
Gabelstapler

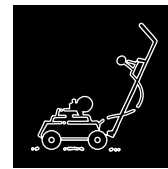

Corta cesped

Belarra mozteko makina
Lawn-mower
Tondeuse
Rasenmäher

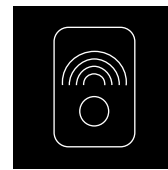

Alarma - llave

Alarma - giltza
Alarm - key
Alarme - clef
Alarm - Schlüssel

KUWAIT
MEXICO
NORWAY
THE NETHERLANDS
PORTUGAL
PERU
POLAND
ARGENTINA

KW
MEX
N
NL
P
PE
PL
RA

TAIWAN
CHILE
CHEKIA
RUMANIA
SWEDEN
FINLAND
SLOVENIA
RUSIA

RC
RCH
RCZ
RU
S
SF
SLO
RUS

CHINA
TUNISIA
UNITED STATES OF AMERICA
YUGOSLAVIA
VENEZUELA
ZAMBIA

TJ
TN
USA
YU
YV
Z

ÍNDICE
AURKIBIDEA
INDEX
INDEX
GESAMTVERZEICHNIS



SUPLEMENTO-SUPPLEMENT
C.11 2018

THE KEY TO EXCELLENCE
GLOBALLY UNLOCKING MILLIONS OF DOORS DAILY

ÍNDICE GENERAL

INDIZE OROKORRA • GENERAL INDEX • INDEX GENERALE • GESAMTVERZEICHNIS

REF.	PAG.
101-1G	24
101-2G	24
716-1G	24
716-2G	24
ABU-35DP	1,18
ABU-70D	1
ABU-87P	1,18
ABU-88P	1,18
ABU-89D	1
ABU-90	1
ABU-91	1
ABU-92	1
ABU-92D	1
ABU-93	2
ABU-94D	1
ABU-96	2
ABU-99D/1	1
ABU-99D/2	1
ABU-99D/3	1
AGA-55D	2
AMG-11	2
AS-30D	2
AX-5DP1	18
AX-6	2
AZ-37D WINDCOLOR	2
BAB-13/12	2
BAB-13-1	2
BAB-13-10	2
BAB-13-11	2
BAB-13-2	2
BAB-13-3	2
BAB-13-4	2
BAB-13-5	2
BAB-13-6	2

REF.	PAG.
BAB-13-7	2
BAB-13-8	2
BAB-13-9	2
BAB-20D/2	2
BA0-1	2
BA0-1D	2
BK-16/11	3
BK-21/10	3
BK-21/16	3
BK-21/4	3
BK-21/5	3
BK-21/6	3
BK-22	2
BK-23	2
BK-26/125	3
BK-26/135	3
BK-26/145	3
BK-26/235	3
BK-26/237	3
BK-26/245	3
BK-26/246	3
BMB-3	3
BMB-4	3
BMB-5	3
BRI-1	24
BRI-19 WINDCOLOR	3
BRI-2	24
BRI-3	24
BRN-1D	3
BRN-2D	3
BUR-35D	4
BUR-36	4
BUR-36D	4
BUR-37D	4

REF.	PAG.
BUR-38	3
BUR-39	4
BUR-39D	4
CAY-1D WINDCOLOR	4
CE-136D/1	4
CE-136D/2	4
CE-136D/4	4
CE-136D/5	4
CI-48P	5
CI-71P	5
CI-72P	5
CI-73P	5
CI-75P	5
CI-76P	5
CI-77P	5
CI-78P	5
CI-79P	5
CI-80P	5
CI-81	4
CI-81P	5
CI-82P	5
CI-83P	5
CI-84P	5
CI-DL WINDCOLOR	5
CIT-1C1	21
CLA-1G	24
CLA-2G	25
CLA-4G	25
CNP-2D	4
COR-1D WINDLOR	5
COR-230	5
COR-231	5
COR-232D	5
COR-61	5

REF.	PAG.
COR-70	5
CRF-1D	4
CVL-5D WINDCOLOR	5
CVL-5I WINDCOLOR	5
DAC-4DP	18
DAC-7DC1	18
DAT-15P4	20
DBX-1D	6
DEB-1	25
DEB-3	25
DEK-16	5
DEK-17	5
DEN-1	25
DOM-75	6
DOM-76D	6
DOM-77D	6
DOM-78D	6
DOM-79D	6
DOM-80	6
DOM-80D	6
DOM-B2	6
DOM-B6	6
DR-2D	5
ELB-2G	25
ELB-3G	25
ELZ-13	6
EU-15P	18
EU-16DP	18
EU-17	7
EUB-2D	6
EUP-4D	7
EUS-1G	25
EV-14	7
EV-15D	7

REF.	PAG.
EVE-2	7
EZ-DS15R WIND-COLOR	7
FAC-25	7
FAIN-1I WINDCOLOR	7
FAV-3D	7
FER-2D	8
FIC-400	26
FO-24C3	18
FO-24C8	18
FO-24C9	18
FO-43D	18
FV-3	8
GARD-2G	26
GE-22/1	8
GE-22/11	8
GE-22/12	8
GE-22/13	8
GE-22/15	8
GE-22/16	8
GE-22/2	8
GE-22/3	8
GE-22/4	8
GE-22/5	8
GE-22/6	8
GE-22/7	8
GEA-9/1	8
GEA-9/10	8
GEA-9/11	8
GEA-9/13	8
GEA-9/14	8
GEA-9/3	8
GEA-9/4	8
GEA-9/6	8

ÍNDICE GENERAL

INDIZE OROKORRA • GENERAL INDEX • INDEX GENERALE • GESAMTVERZEICHNIS

REF.	PAG.	REF.	PAG.	REF.	PAG.	REF.	PAG.	REF.	PAG.
GEA-9/7	8	IS-3D WINDCOLOR	9	MERI-2DP	20	SA-5D	13	TX-13D	15
GEA-9/9	8	ITO-3D	9	MH-1	11	SEA-2	13	U-15D WINDCOLOR	15
GEA-9D/12	8	JP-1	26	MIT-8DP2	20	SEL-1	28	U-5D WINDCOLOR	15
GEA-9D/2	8	JP-2	26	MLM-8	11	SUZU-12P	21	U-5I WINDCOLOR	15
GEA-9D/5	8	JP-3	27	MOI-4G	27	SUZU-21P	21	U-6D WINDCOLOR	15
GEA-9D/7	8	JP-4	27	MOI-5G	28	SUZU-8IP	20	UCEM-19	15
GEA-9D/8	8	JP-5	27	MT-1P	11	SWL-1	13	UCEM-20D	15
GER-2G	26	JP-6	27	MT-2D	11	TC-3	13	UCEM-8D WINDCO- LOR	15
GER-3G	26	KA-7 WINDCOLOR	9	MUE-1	11	TE-8I WINDCOLOR	13	VA-1T	28
GER-4G	26	KE-6	9	MUE-2	11	TE-T60 WINDCOLOR	13	VA-2T	28
GER-5G	26	KI-11P	20	NE-60C3	20	TE-T80EH	13	VA-3T	28
GOD-3	8	KI-12DP	20	OJ-20/4	11	TOK-82	14	VA-400	28
GOD-4	8	KI-12P	20	OMC-7	11	TOK-83	13	VA-5T	28
GUA-4	8	KM-1P	20	OP-11C3	19	TOK-83D	13	VA-61C3	21
GUA-4D	8	KUB-2D	20	PFA-23D	11	TOK-84D	14	VA-700	28
GUA-5	8	KWI-1K	9	PFA-24	12	TOK-85D	14	VA-75D WINDCOLOR	15
GUA-5D	8	LAP-100	27	PFA-24D	12	TOK-86D	14	VA-8D WINDCOLOR	15
HAF-6	8	LAP-3	27	PFA-25	12	TOV-8D	14	VA-91	15
HEK-4D	8	LB-2MD	10	PFA-25D	12	TOYO-15DP	21	VO-HVP1	19
HEK-5	8	LB-5D	10	PFA-26D	12	TOYO-40	21	VO-KP	19
HEK-6	8	LF-47	10	PR-21	12	TRI-17	14	YA-280D	15
HGO-1	9	LF-50D	10	PR-22	12	TRL-3	14	YA-281D	16
HOK-1D	9	LIN-21D WINDCOLOR	10	PTN-12G	28	TRL-3D	21	YA-282	16
HOK-2D	9	LIN-25D WINDCOLOR	10	PTN-3D	12	TRL-4P	21	YA-300D	16
HU-4C1	19	LIN-26D	10	RE-5	12	TRL-5P	14	YAMA-25P	21
HUD-3D	9	MAF-1	27	RO-29D WINDCOLOR	12	TRL-6	14	YAMA-32DP	21
HU-HCAP	19	MAU-1	10	RO-43	12	TRL-6D	14	YAMA-33P1	22
HY-10	19	MAU-2	10	RO-44D	12	TV-34	14	YAR-4D	16
HY-11P4C1	19	MAU-3D	10	ROD-1	12	TV-35	14	YUH-3D	16
HY-18P1C1	19	MAU-4D	10	ROD-1D	12	TV-36	14	ZA-9P2	22
HY-19DP5	19	MAU-5D	10	RSS-3	13	TV-37	14	ZE-160D	9
HY-19P5	19	MCM-15E8	11	RSS-3D	13	TV-38	15		
IF-7	9	MERI-1DP1	20	RU-1	12	TV-39	14		
IS-21D	9	MERI-1P1	20	RU-1D WINDCOLOR	13	TX-12	15		

ÍNDICE DE MARCAS

MARKEN AURKIBIDEA • BRAND INDEX • INDEX MARQUE • HAUPTMARKE

MARCA / BRAND	PAG.
101	24
716	24
ABUS	1,2,3,4,5,11,18
AGA	2
AMIG	2
ASSA	2
AXA	2,5,18
AZBE	2
BAB	2
BAODELI	2
BIFFAR	14
BKS	2,3
BMB	3
BRABANTIA	6
BRICARD	3,9,24
BRISANT	3
BUFFO	1,18
BURG	3,4
BURG WACHTER	4
CANADA POST	4
CARL F	4
CAYS	4
CEM	10
CES	4
CIBOX	3
CISA	1,4,5
CITROEN	21
CLASS	24
CORBIN	5,6
CORONA	9
CVL	5
DACIA	18
DEBEAURAIN-ND	25
DEKABA	5
DENY	25
DIERRE	5
DINBOX	6
DOM	6
DONNER	9
ELBOR	25
ELCA	7
ELZETT	6
ESAFE	13,15
EURO BOX	6
EURO LOCKS	6,10,18
EUROSPEC	15,25
EVERGOOD	7

MARCA / BRAND	PAG.
EVVA	7
EZCURRA	7,13
FAC	7
FAINER	7
FAVOUR	7
FCV	8
FEDERAL	3
FERONERIA	8
FICHET	14,25
FINA	11
FLOK	15
FORD	18
FORT	9
GARDIAN	26
GE GE	7,8
GERA	8
GERDA	7
GERION	25
GEVY	11
GODREJ	8
GUARD	8
GUARDIAN	25
HÄFELE	8
HASLER	13
HEKNA	8
HOBBY	18
HOK	9
HOPPE	3
HUDSON	9
HUF	18,19
HUGO	9
HYMER	18
HYUNDAI	19
IFAM	9
IKON	9
ILARGI	4
ISEO	9
ISEO SILVER	9
ITO	1,9
JOLI SAFE	15
JPM	25
KABA	9
KESO	9
KFV	8
KIA	19,20
KIND	3
KTM	20

MARCA / BRAND	PAG.
KUBOTA	20
KWIKSET	9
LAPERCHE	25
LASBOLAGET	9
LEHMANN	11
LINCE	10
LOB	10
LOWE & FLETCHER	6,10
MAFOR	25
MAHINDRA RE-NAULT	20
MARS	6
MASTER	9
MAUER	5,10
MCM	11
MEGA	9
MERIT LINDE	20
METALCASTELLI	8
MHA	11
MITSUBISHI	20
MLM	11
MOIA	25,26
MOTTURA	11
MUEL	11
NEIMAN	19,20
NEMEF	4
NISSAN	20
OJMAR	11
OMEC	11
OMR	27,28
OPEL-CHEVROLET	19
PETCO	9
PAFFENHAIN	11,12
POSSE	9
POTENT	12,26
PREFER	12
PUCH	21
RAUCO	8
REGENT	8
RENZ	12
RODES	12
RONIS	12
ROTO	3
RUKO	12,13
RUSSIA	13
SAMSONITE	13
SANTOS	11

MARCA / BRAND	PAG.
SCHRITT	9
SEA	13
SELECT	26
SHAW WALKER	13
SHERLOCK	8
SIB	4
SIL	7,15
STORWALL	13
STS	6,13
STV	11
SUZUKI	20,21
TECON	13
TESA	13
THOMAS LAIDLAW	13
TITAN	15
TOK WINKHAUS	13,14
TOKAJ RIKA	21
TOPLOCK	11,13
TOVER	14
TOYOTA	21
TRELOCK	14,21
TRI CIRCLE	14
TRIO-VING	14,15
TROMER	14
TRYBA	7
UCEM	15
ULTION	3
ULTRA	10
UNION	10
UNIVERSAL	15
VACHETTE	9,15,21,26,27
VALEO	21
VBH	8
VESPA	21
VF (VEROFER)	8
VIDMAR	13
WEDO	6
WITTE	18
WSS	8
WÜRTH	8
YALE	15
YAMAHA	21,22
YARDENI	15
YEMAR	13
YUN HUAN	15
ZADI	22

LLAVES PLANAS PARA CERRADURAS DE CILINDRO

SARRAILA ZILINDRIKOTARAKO GILTZA ZAPALAK

CYLINDER KEYS

CLÉS POUR CYLINDRES

ZYLINDERSCHIÜSSEL



SUPLEMENTO-SUPPLEMENT

C.11 2018

THE KEY TO EXCELLENCE
GLOBALLY UNLOCKING MILLIONS OF DOORS DAILY

ABUS

PARA-FOR:
ABUS (D)

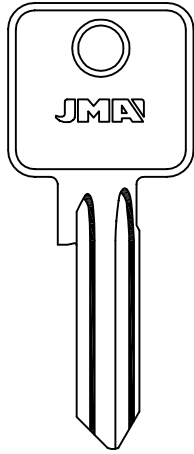

ABU-48

ABU-58D

K1D
 ABU-70

ABU-70D **NEW**

ABU-77

ABU-80

ABU-83

X4S
* ABU-85

ABU-17

ABU-17D

* LAT.

CISA

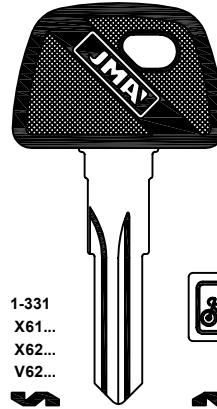

1-331
X61...
X62...
V62...

ABU-35.P

ABU-35D.P **NEW**

1-331
V61...
V62...

ABU-36.P

BUFFO

ABUS

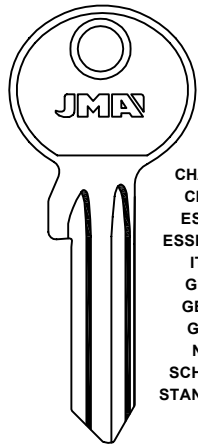

CHAVO
CISA
ESCO
ESSENDIA
ITO
GEFI
GETE
GTV
NB
SCHUCO
STANDARD

ABU-41

ABU-41D

ABU-68

ABU-92 **NEW**

ABU-92D **NEW**

ABU-99D/1 **NEW**

ABU-99D/2 **NEW**

ABU-99D/3 **NEW**

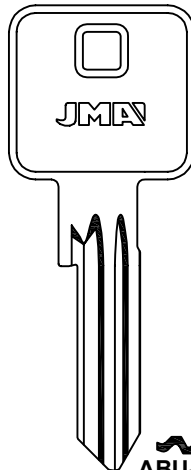

ABU-86D

E60
 ABU-94D **NEW**

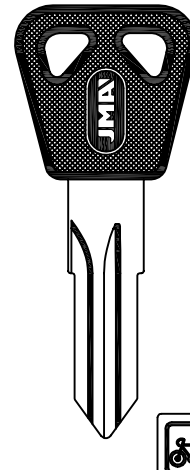

NW52
 ABU-87.P **NEW**

ABUS

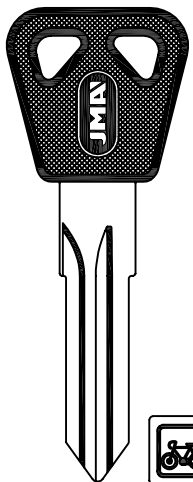

NW72
 ABU-88.P **NEW**

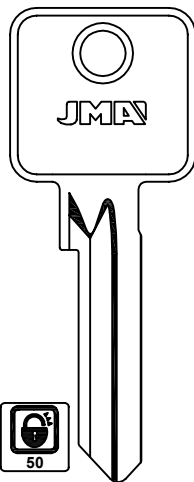

SERIE 90/50
 ABU-89D **NEW**

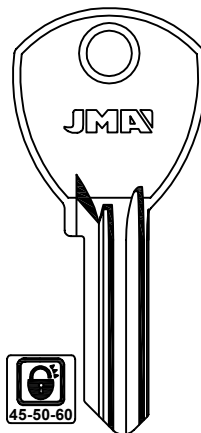

SERIE 64TI
 ABU-90 **NEW**

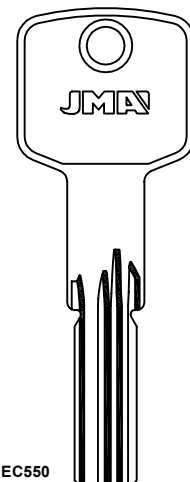

LAT.

EC550
8.2
2.8
 ABU-91 **NEW**

JMA®











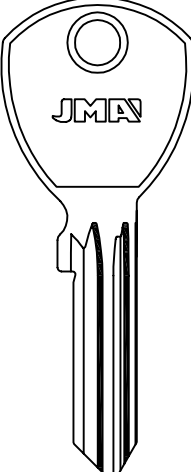
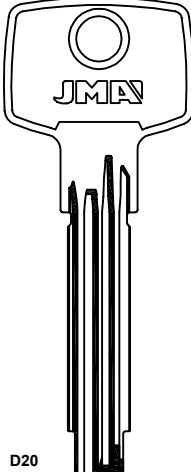
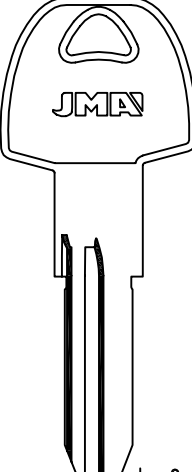
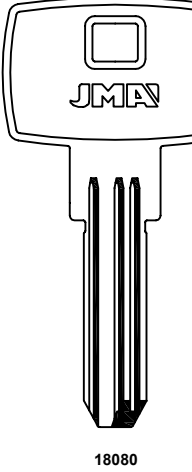
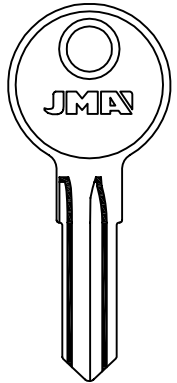
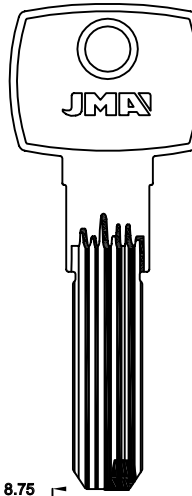
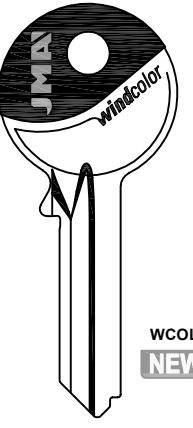
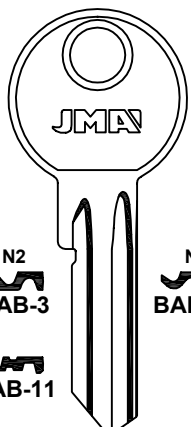
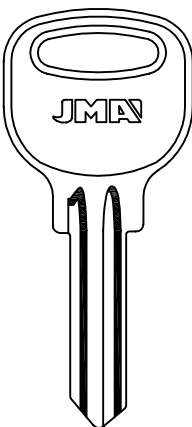
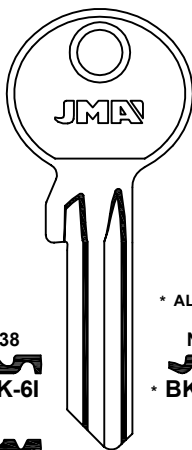







Copyright by Alejandro Altuna S.L.U. 2018



ATENCIÓN: Concerniente a las marcas y denominaciones comerciales ver nota en índice.
ATTENTION: Concerning the marks and commercial denominations see note in index.
ATTENTION: Concernant les marques et dénominations commerciales voir la note dans l'index.
ACHTUNG: Beziehen auf die marke und handelsname sehen sie die notiz im index.

PARA-FOR:

- ABUS (D)
- AGA (E)
- AMIG (E)
- ASSA (S)
- AXA (S)
- AZBE (E)
- BAB (D)
- BAODELI (TJ)
- BKS (D)

ABUS	AGA	AMIG
 ABU-93 NEW	 <small>D20</small> <small>8.20</small> <small>2.8</small> ABU-96 NEW	 AGA-55D NEW
	LAT.	ALP.
		 <small>18080</small> <small>8.3</small> <small>2.5</small> AMG-11 NEW
		LAT.
ASSA	AXA	AZBE
 AS-30D NEW	 <small>8.75</small> <small>2.75</small> AX-6 NEW	 AZ-37D WCOLOR NEW
	LAT.	
BAB	BAODELI	BKS
 BAB-12D	 BAO-1 NEW	 BK-22 NEW
<small>N2</small>  BAB-3  BAB-11	<small>206</small>  BAB-13/1 NEW <small>307</small>  BAB-13/3 NEW <small>406</small>  BAB-13/5 NEW  BAB-13/7 NEW  BAB-13/9 NEW  BAB-13/11 NEW	<small>209</small>  BAB-13/2 NEW <small>210</small>  BAB-13/4 NEW <small>407</small>  BAB-13/6 NEW <small>510</small>  BAB-13/8 NEW  BAB-13/10 NEW <small>310</small>  BAB-13/12 NEW
	LAT.	
		<small>38</small>  BK-6I  BK-23 NEW  BK-6D NEW
		<small>* ALU.</small>  <small>NA</small> <small>* BK-6D</small>



BKS

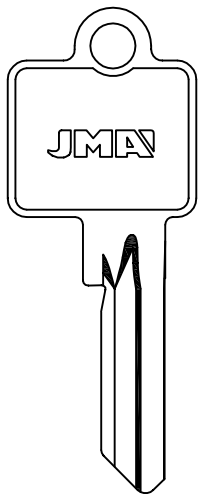

- BK-21/1
- BK-21/2
- NEW** BK-21/4
- NEW** BK-21/5
- BK-21/6 **NEW**
- BK-21/7
- NA** BK-7D
- BK-21/9
- BK-21/10
- BK-21/14
- NEW** BK-21/16
- BK-21/17
- BK-21/19
- SE** BK-26/125 **NEW**
- SE** BK-26/135 **NEW**
- SE** BK-26/145 **NEW**
- SE** BK-26/235 **NEW**
- SE** BK-26/237 **NEW**
- SE** BK-26/245 **NEW**
- SE** BK-26/246 **NEW**

PARA-FOR:

- BKS (D)
- BMB (D)
- BRICARD (F)
- BRISANT (GB)
- BURG (D)

BKS

BMB

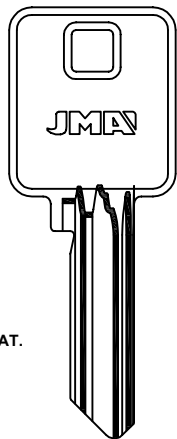

* LAT.

- * BK-16/7
- * BK-16/5
- * BK-16/4
- * BK-16/3
- * BK-16/2
- * BK-16/1
- * BK-16/0
- * BK-16/16
- * BK-16/15
- * BK-16/14
- * BK-16/13
- * BK-16/11 **NEW**
- * BK-16/10
- * BK-16/9
- BK-16/30
- * BK-16/23
- * BK-16/21
- * BK-16/20
- * BK-16/19
- * BK-16/18
- * BK-16/17

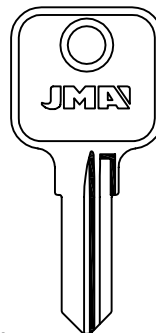

- A** BMB-1
- BMB-3 **NEW**
- M** BMB-3D
- A...201-400
- BMB-4 **NEW**
- SERIE 2000

BMB

BRICARD

BRISANT

BURG

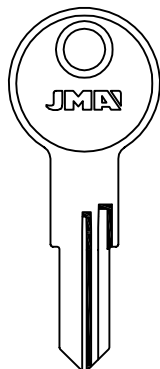

BMB-5 **NEW**

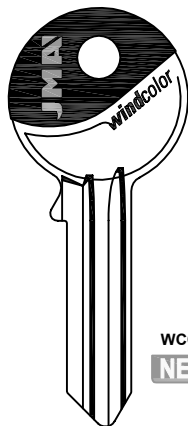

WCOLOR
NEW

BRI-19

ABUS

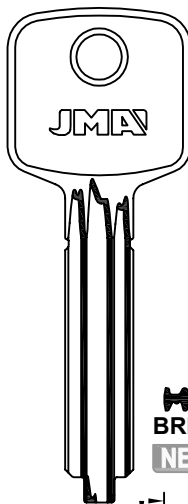

LAT.

BRN-2D **NEW**

NEW BRN-1D

ULTION - FEDERAL

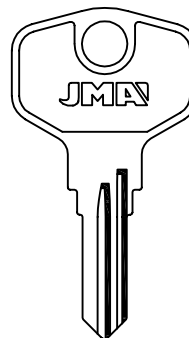

BUR-10 BUR-10D

BUR-38 **NEW**

CIBOX-HOPPE-KIND-ROTO



PARA-FOR:

- BURG (D)
- CANADA POST (CDN)
- CARL F (GB)
- CAYS (E)
- CES (D)
- CISA (I)

BURG

BUR-14 BUR-14D
 BUR-19D BUR-37D
 BUR-35D BUR-36 BUR-36D
 BUR-39 BUR-39D

BURG WACHTER **NEW** BURG WACHTER
 BURG WACHTER **NEW** **NEW** **NEW** **NEW** **NEW**

CANADA POST

CARL F

CAYS

LAT.

CNP-2D
NEW

GRF-1D
NEW

WCOLOR
NEW

CAY-1D
ILARGI-SIB

CES

CISA

CE-71 * CE-7D CE-8D

* MTIC.

S S S S
 CE-136D/1 CE-136D/2 CE-136D/4 CE-136D/5
NEW **NEW** **NEW** **NEW**

NEMEF

LAT.

CI-81 CI-73 CI-72
NEW

8.20 8.2
 2.85 2.85 CI-48 CI-71

ABUS - GERDA



CISA

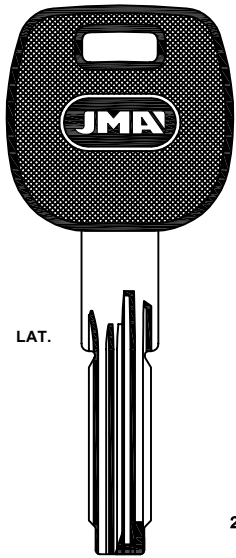

-  **NEW**  **NEW**
- CI-77.P** **CI-84.P**
-  **NEW**  **NEW**
- CI-76.P** **CI-83.P**
-  **NEW**  **NEW**
- CI-75.P** **CI-82.P**
-  **NEW**  **NEW**
- CI-73.P** **CI-81.P**
-  **NEW**  **NEW**
- CI-72.P** **CI-80.P**
-  **NEW**  **NEW**
- CI-71.P** **CI-79.P**
-  **NEW**  **NEW**
- CI-48.P** **CI-78.P**

ABUS

CORBIN

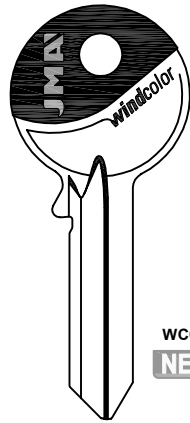

WCOLOR
NEW

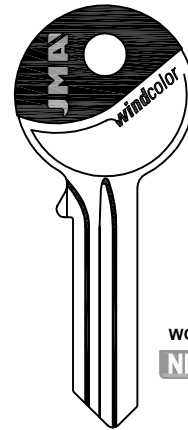

WCOLOR
NEW



PARA-FOR:

- CISA (I)
- CORBIN (I)
- CVL (E)
- DEKABA (GB)
- DIERRE (I)

CORBIN

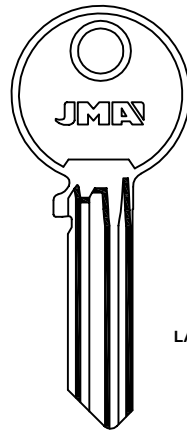
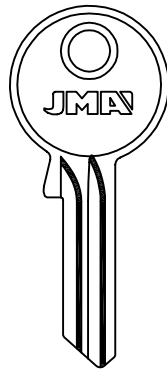
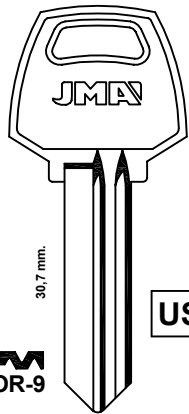

LAT.

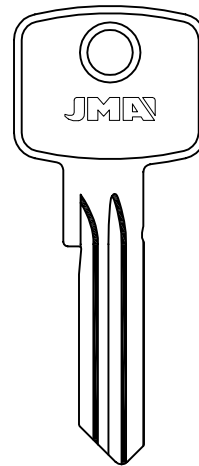

CVL

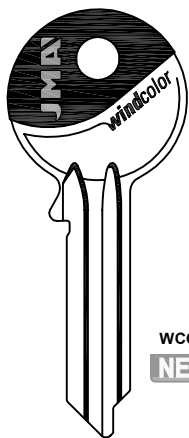

WCOLOR
NEW



DEKABA

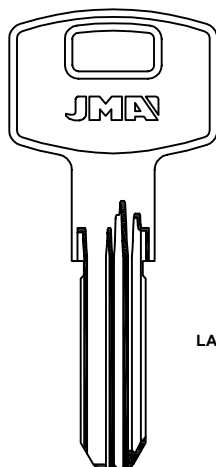

LAT.



MAUER-AXA

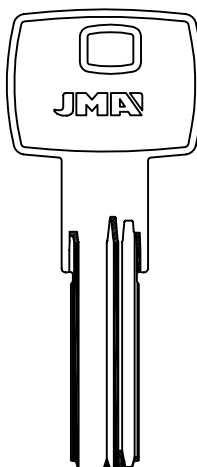

LAT.

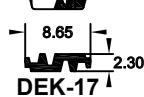

DIERRE

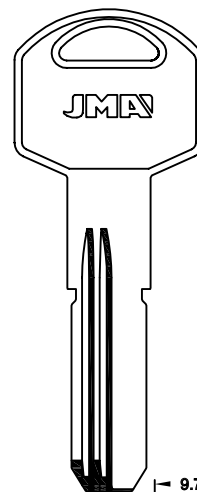

LAT.

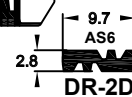

PARA-FOR:

DINBOX (N)

DOM(D)

ELZETT (H)

EURO BOX

DINBOX	DOM	
DBX-1D NEW	NEW	NEW
	DOM-45	DOM-46D
	DOM-44D	DOM-25D
	DOM-21D CORBIN	DOM-49D
		DOM-76D NEW

DOM		
DOM-77D NEW	NEW	NEW
	DOM-2D	DOM-79D
	DOM-2D	DOM-80

DOM	ELZETT	EURO BOX
DOM-B1	NEW	NEW
DOM-B2 NEW	NEW	NEW
CORBIN-ST		BRABANTIA-MARS-WEDO



EUROLOCKS

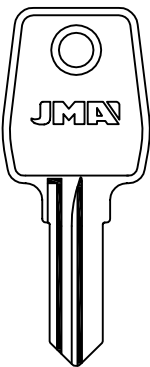

KB
1-500
EU-17
NEW



L&F

EURO-PROFIL

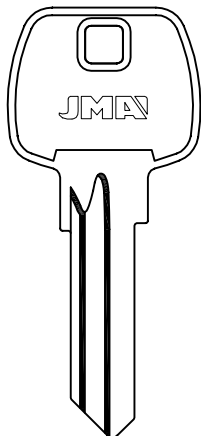

EUP-4D
NEW

GERDA

EVERGOOD

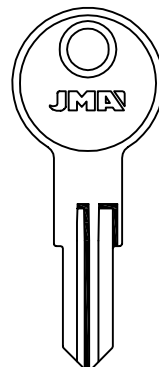

EVE-2 EVE-2D
NEW

PARA-FOR:

- EUROLOCKS (B)
- EURO-PROFIL (PL)
- EVERGOOD (RC)
- EVVA (A)
- EZCURRA (E)
- FAC (E)
- FAINER (P)
- FAVOUR (DZ)

EVVA

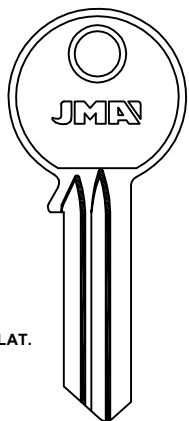

* LAT.

- A
EV-1
- C
EV-2
- F
EV-3D
- E
EV-13D
- 2C
EV-2I
- 2F
EV-3I
- NEW** EV-15D
- M
* EV-25D

ELCA

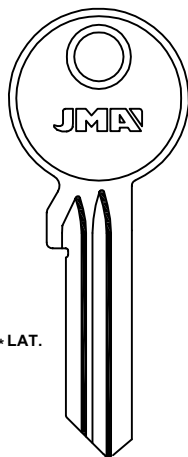

* LAT.

- A
EV-6D
- C
EV-7D
- F
EV-8D
- S
EV-9D
- NEW** * EV-14
- EV-23D
- * EV-27D/5
- * EV-27D/10
- * EV-27D/4
- * EV-27D/9
- * EV-27D/3
- * EV-27D/8
- * EV-27D/2
- * EV-27D/7
- * EV-27D/1
- * EV-27D/6

ELCA-TRYBA-GE-GE

EZCURRA

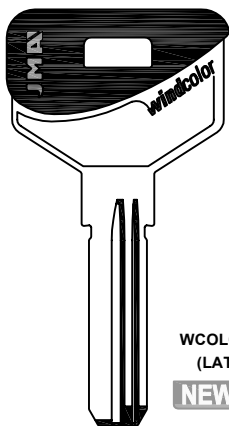

WCOLOR (LAT.)
NEW



EZ-DS15R

FAC

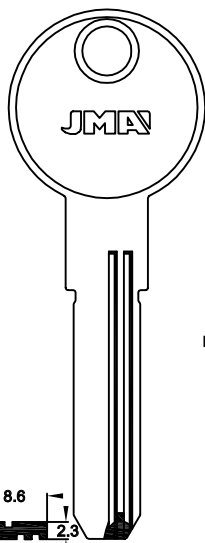

LAT.



FAC-25
NEW

FAINER

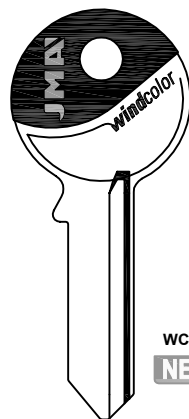

WCOLOR
NEW

FAIN-1I

SIL

FAVOUR

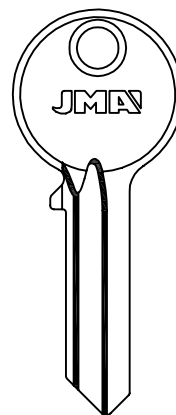









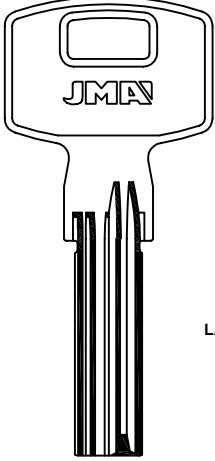

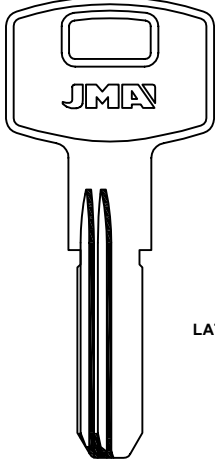

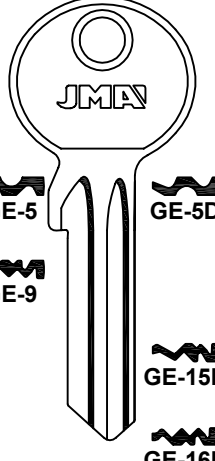



FAV-3D
NEW



PARA-FOR:

- FCV (D)
- FERONERIA (RU)
- GE GE (A)
- GERA (D)
- GODREJ (IND)
- GUARD (HK)
- HÄFELE (D)
- HEKNA (D)

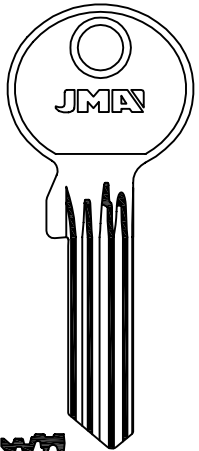
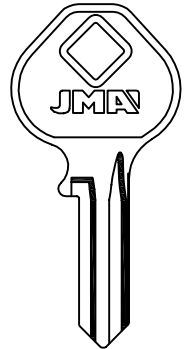
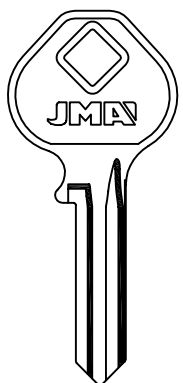
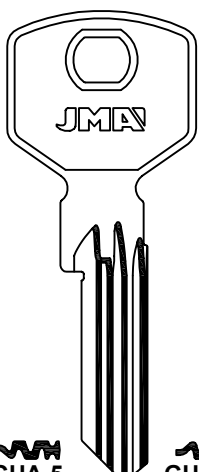
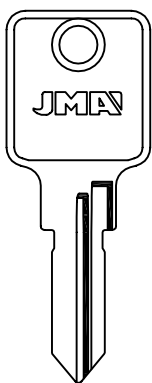
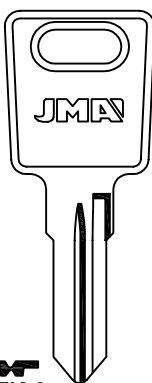
FCV	FERONERIA	GE GE	
 <p>LAT.</p>  <p>NEW FV-3 KfV-VBH</p>	 <p>LAT.</p>  <p>NEW FER-2D VF (VEROFER)</p>	 <p>GE-5 GE-5D GE-9 GE-15D GE-16D GE-19</p>	 <p>NEW GE-22/1</p>  <p>NEW GE-22/2</p>  <p>NEW GE-22/3</p>  <p>NEW GE-22/4</p>  <p>NEW GE-22/5</p>  <p>NEW GE-22/6</p>  <p>NEW GE-22/7</p>  <p>NEW GE-22/11</p>  <p>NEW GE-22/12</p>  <p>NEW GE-22/13</p>  <p>NEW GE-22/15</p>  <p>NEW GE-22/16</p>
GERA		GODREJ	
 <p>GEA-9/1 NEW GEA-9D/2 NEW GEA-9/4 NEW GEA-9/3 NEW</p>	<p>GEA-9/9 NEW GEA-9D/8 NEW GEA-9D/7 NEW GEA-9D/5 NEW GEA-9/14 NEW GEA-9/13 NEW GEA-9D/12 NEW GEA-9/11 NEW GEA-9/10 NEW</p>	 <p>NEW GOD-3 SHERLOCK</p>	
GODREJ	GUARD	HÄFELE	HEKNA
 <p>NEW GOD-4 SHERLOCK</p>	 <p>GUA-5 NEW GUA-4 NEW GUA-5D NEW GUA-4D NEW</p>	 <p>NEW HAF-6 WSS-WÜRTH</p>	 <p>HEK-6 NEW HEK-5 NEW1501-1540 NEW HEK-4 HEK-4D</p> <p>METALCASTELLI-RAUCO-REGENT</p>



HOK		HUDSON		HUGO	
LAT.		LAT.			
 9.20 2.50 HOK-1D NEW MEGA	 HOK-2D NEW	... 01-175 HUD-3 NEW	 HUD-3D NEW	 HGO-1 NEW	
IFAM		IKON		ISEO	
	K2	K1	K6	K5	
	ZE-K2	ZE-K1	ZE-K6	ZE-K5	
 IF-7 NEW	 ZE-160D NEW	 ZE-160D NEW			 IS-21D NEW
	CORONA-FORT-SCHRITT				ISEO SILVER
			 F5 IS-3D	 F3 IS-15	
ITO		KABA		KESO	
LAT.					
 8.5 2.4 ITO-3D NEW	 7.85 8 1.95 KA-7 NEW	 7.6 2.48 KE-6 NEW			1 AL 7 KWI-1K NEW
	LÄSBOLAGET				BRICARD EZSET VACHETTE DONNER PETCO MASTER POSSE
					ALP.

PARA-FOR:
 HOK (TR)
 HUDSON (USA)
 HUGO (D)
 IFAM (E)
 IKON (D)
 ISEO (I)
 ITO (TR)
 KABA (CH)
 KESO (CH)
 KWIKSET (USA)







PARA-FOR:

LINCE (E)

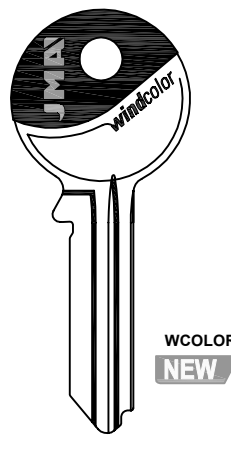
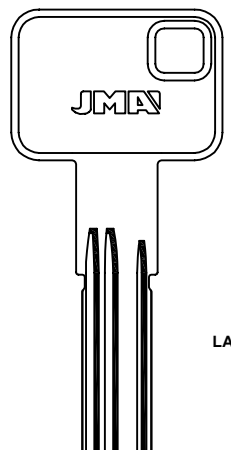
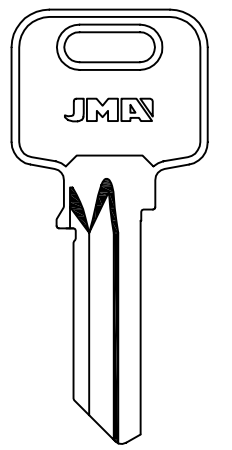

LOB (PL)

L.&F. (GB)



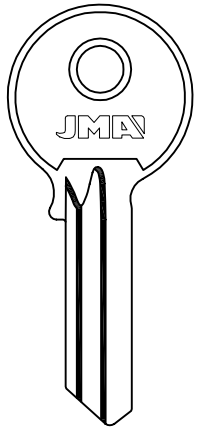
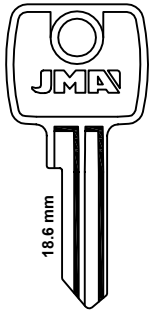
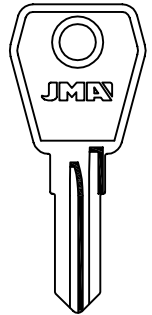

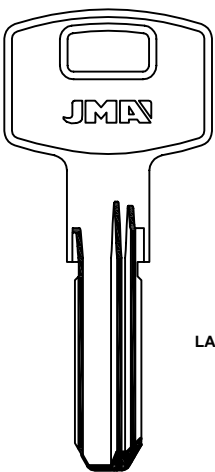
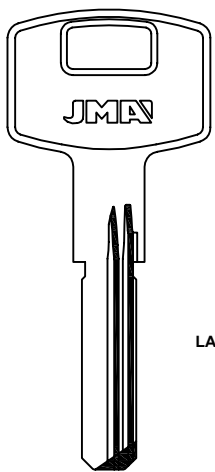
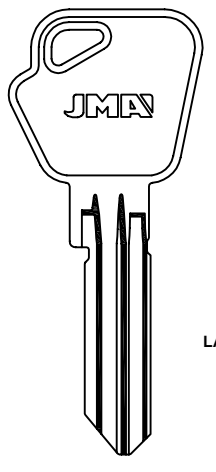
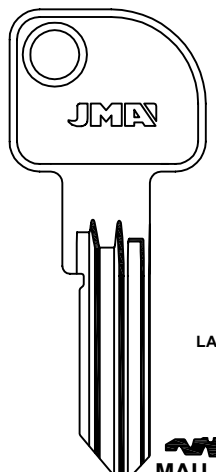
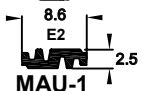
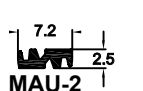





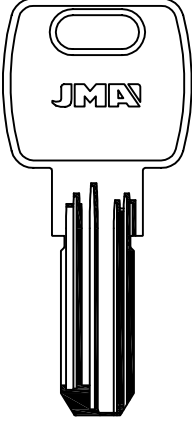
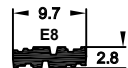
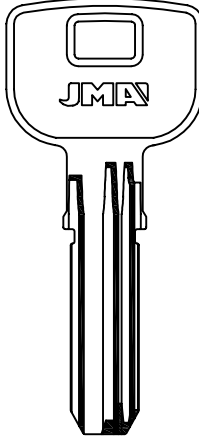
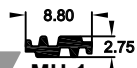
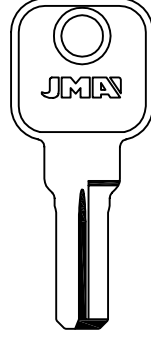

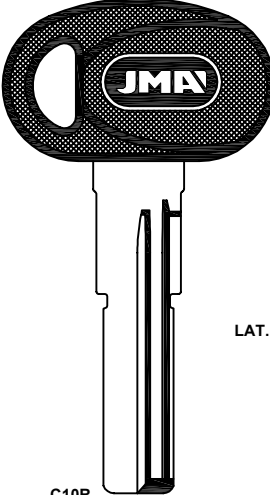

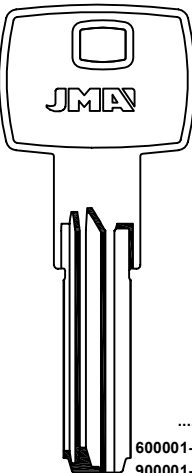

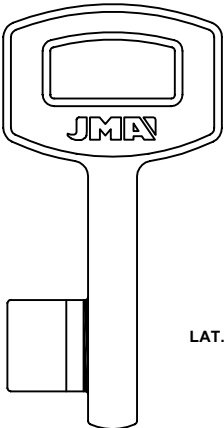
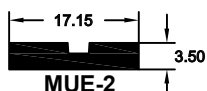

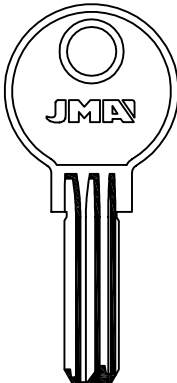
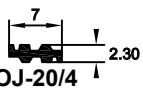
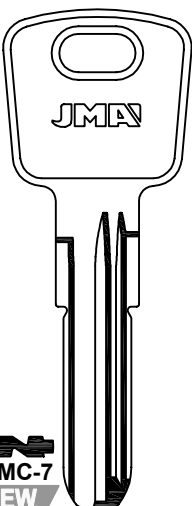
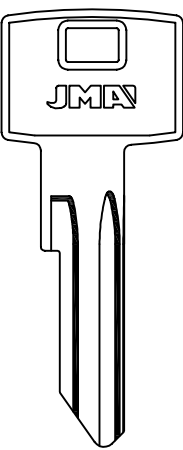

MAUER (NL)

LINCE		LOB	
			
WCOLOR (LAT.) NEW	WCOLOR NEW	LAT.	
 LIN-21D	 LIN-25D	 LIN-26D NEW	 LB-2MD NEW

LOB	LOWE & FLETCHER	
		
LB-5D NEW	18.6 mm LF-15 FFE 001-100 LF-17 NEW LF-47 CEM-EURO LOCKS-ULTRA-UNION	60... 001-200 60... 001-200 90... 001-200 ...1-400 GHM...1-155 M...1-400 RV...1-400 RVM...1-400 SP...1-400 99...1-400 LF-15D LF-46 LF-50D NEW

MAUER			
			
LAT.	LAT.	LAT.	LAT.
 MAU-1 NEW	 MAU-2 NEW	 MAU-3D NEW	 MAU-5D NEW MAU-4D NEW



MCM	MHA	MLM	MOTTURA
 <p>LAT.</p>  <p>9.7 E8 2.8 MCM-15E8 NEW</p>	 <p>LAT.</p>  <p>8.80 2.75 MH-1 NEW TOP LOCK</p>	 <p>LAT.</p>  <p>MLM-8 NEW LEHMANN</p>	 <p>LAT.</p>  <p>C10R MT-1.P NEW</p>
MOTTURA	MUEL	OJMAR	
 <p>LAT.</p> <p>600001-613040 900001-902780</p>  <p>8.9 2.8 MT-2D NEW GEVY-STV</p>	 <p>LAT.</p>  <p>17.15 3.50 MUE-2 NEW</p>  <p>MUE-1 NEW</p>	 <p>LAT.</p>  <p>7 2.30 OJ-20/4 NEW</p>	
OMEC	PFAFFENHAIN		
 <p>LAT.</p> <p>OMC-7 NEW OMC-3</p> <p>SANTOS</p>	 <p>LAT.</p> <p>PFA-4</p> <div style="display: flex; flex-wrap: wrap;"> <div style="width: 33%;"> <p>EA  PFA-13D</p> <p>EB  PFA-14D</p> <p>EH  PFA-15D</p> <p>A21  PFA-10D</p> <p>A22  PFA-11D</p> <p>A23  PFA-12D</p> </div> <div style="width: 33%;"> <p>EN  PFA-16D</p> <p>RF  PFA-17D</p> <p>RG  PFA-18D</p> </div> <div style="width: 33%;"> <p>T21 AL T26-T28 T31 AL T42 T44 AL T46 T51-T54-T65 T85-T86-T91 PFA-22</p> <p>A40  PFA-23D FINA A40  PFA-22D ABUS</p> </div> </div>		

PARA-FOR:

- MCM (E)
- MHA (TJ)
- MLM (D)
- MOTTURA (I)
- MUEL (F)
- OJMAR (E)
- OMEC (I)
- PFAFFENHAIN (D)



PARA-FOR:

- PFAFFENHAIN (D)
- POTENT (I)
- PREFER (I)
- RENZ (D)
- RODES (P)
- RONIS (F)
- RUKO (DK)

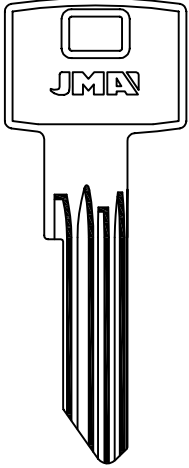
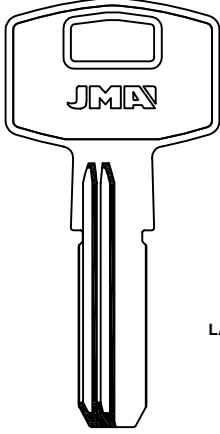
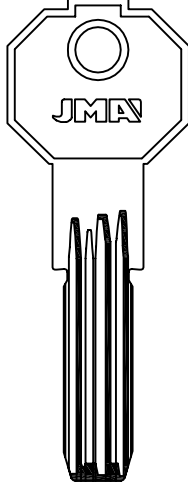
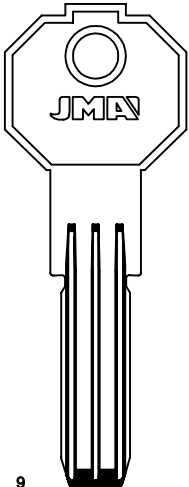
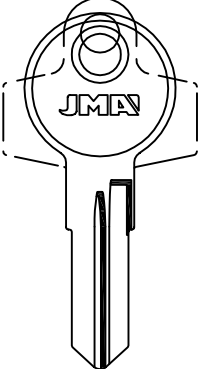
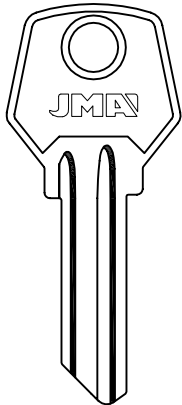
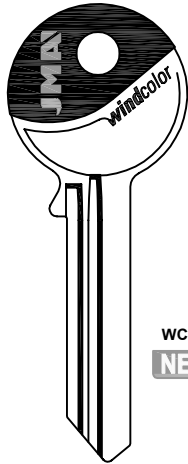
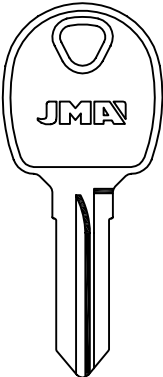
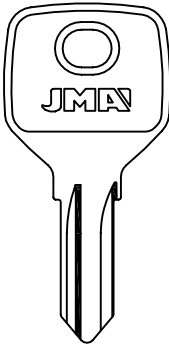
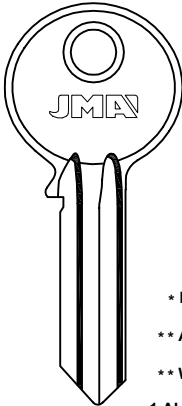
PFAFFENHAIN		POTENT	PREFER
			
<p>A21 PFA-7D</p> <p>A22 PFA-8D</p> <p>A23 PFA-9D</p> <p>PFA-21</p> <p>PFA-24 NEW</p> <p>PFA-25 NEW</p> <p>A24 PFA-6D</p> <p>PFA-6</p> <p>PFA-24D NEW</p> <p>PFA-25D NEW</p> <p>PFA-26D NEW</p>		<p>LAT.</p> <p>PTN-3D NEW</p>	<p>LAT.</p> <p>PR-21 NEW</p>
PREFER	RENZ	RODES	RONIS
			
<p>LAT.</p> <p>PR-22 NEW</p>	<p>RE-5 NEW</p> <p>RE-5D</p>	<p>ROD-1 NEW</p> <p>ROD-1D NEW</p>	<p>WCOLOR NEW</p> <p>RO-29D</p>
RONIS		RUKO	
			<p>RU-21</p> <p>RU-2D</p> <p>RU-3D</p> <p>RU-4D</p> <p>RU-10D</p> <p>* RU-19D</p> <p>RU-TL</p>
<p>RO-43 NEW</p>	<p>CA RO-44D NEW</p>	<p>* LAT.</p> <p>** ALU.</p> <p>** WColor</p> <p>.....1 AL 8</p> <p>.....1 AL 9</p> <p>.....1 AL 9 AL 0 A-B</p> <p>.....0 AL 9 A AL M</p> <p>S.....1 AL 9</p> <p>RU-1 NEW</p> <p>** RU-1D NEW</p>	
		DIFA	

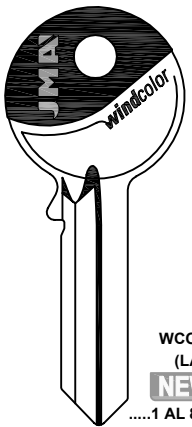
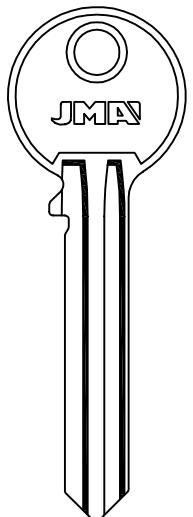
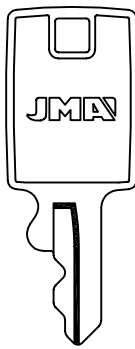
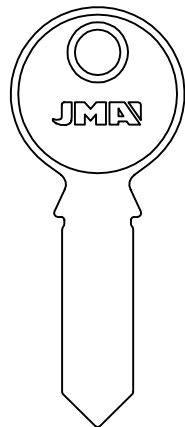

RUKO	RUSSIA	SAMSONITE	SEA
 <p>WCOLOR (LAT.) NEW1 AL 81 AL 91 AL 9 AL 0 A-B0 AL 9 A AL M S.....1 AL 9</p> <p>RU-1D</p> <p>DIFA</p>	 <p>RSS-3 RSS-3D</p> <p>NEW NEW</p>	 <p>SA-5D</p> <p>NEW</p>	 <p>ALP.</p> <p>.....1 AL 7 9.4 2.2</p> <p>SEA-2</p> <p>NEW</p> <p>EZCURRA-HASLER-VIDMAR</p>

PARA-FOR:
 RUKO (DK)
 RUSSIA (RUS)
 SAMSONITE (USA)
 SEA (CH)
 SHAW WALKER (USA)
 TECON (E)
 TESA (E)
 TOK WINKHAUS (D)

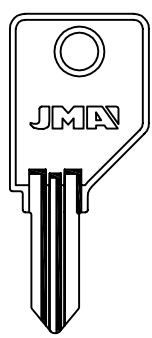
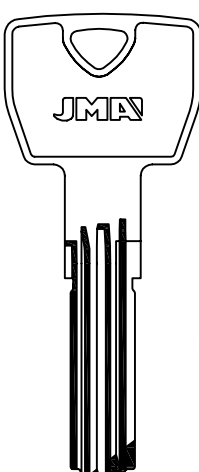
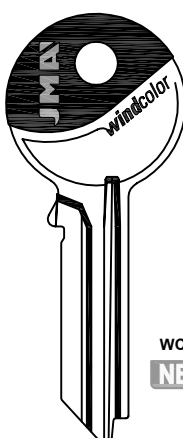
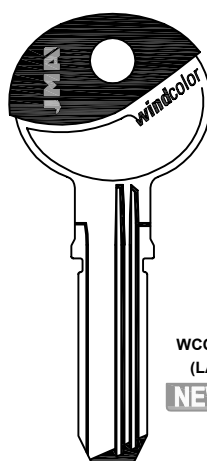
SHAW WALKER	TECON	TESA	
 <p>LAT.</p> <p>SWL-1</p> <p>NEW</p> <p>STORWALL</p>	 <p>LAT.</p> <p>WF 8.30 2.80</p> <p>TC-3</p> <p>NEW</p>	 <p>WCOLOR NEW</p> <p>T..... 0 AL 9</p> <p>TE-81</p>	 <p>WCOLOR (LAT.) NEW</p> <p>8.9 2.8</p> <p>TE-T60</p> <p>THOMAS LAIDLAW</p>

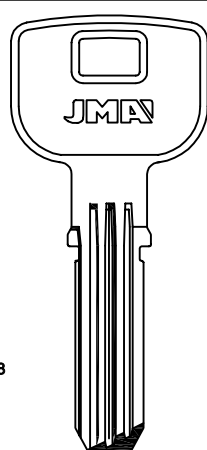
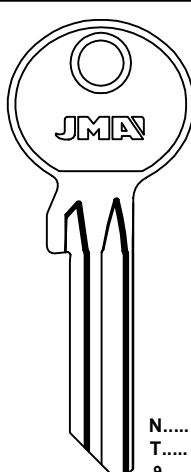
TESA	TOK WINKHAUS
 <p>ALP.</p> <p>8.8 2.8</p> <p>TE-T80</p> <p>EH TE-T80EH NEW</p> <p>SC TE-T80SC</p> <p>ESAFE-ST5-TOPLOCK-YEMAR</p>	 <p>N..... T..... 9.....9 0 AL 8</p> <p>TOK-6 TOK-6D TOK-25</p> <p>TOK-83 TOK-83D NEW NEW</p> <p>TOK-27</p> <p>TOK-26</p>

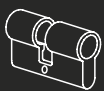

PARA-FOR:
 TOK WINKHAUS (D)
 TOVER (E)
 TRELOCK (D)
 TRI-CIRCLE (RC)
 TRIO-VING (N)

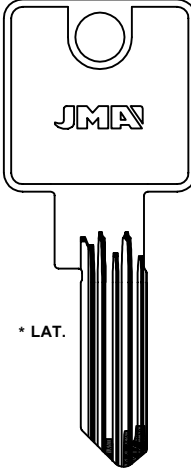
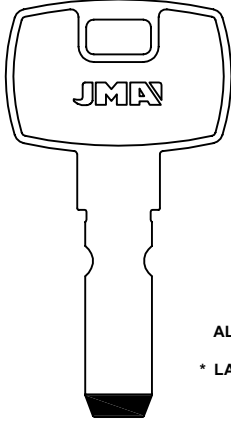
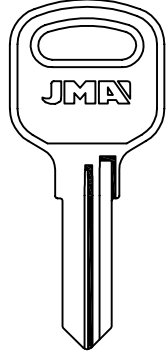
TOK WINKHAUS	TOVER	TRELOCK
 <p>* LAT.</p> <p>ENAX TOK-7D</p> <p>FICHET-BIFFAR</p>	 <p>ALP. * LAT.</p> <p>2F35 8.85 2.45 TOK-86D NEW</p> <p>TOK-32 TOK-33</p> <p>EAFF TOK-23</p> <p>TOK-28D</p> <p>BFA1 TOK-16D</p> <p>BYNY1 TOK-14D</p> <p>EWSB TOK-12</p> <p>FAABF TOK-10D</p> <p>TOK-34D</p> <p>TOK-85D NEW</p> <p>TOK-84D NEW</p> <p>TOK-82 NEW</p> <p>BFA3 TOK-82 NEW</p> <p>BIF-1</p> <p>TOK-4 TOK-8D NEW</p> <p>TROMER</p>	 <p>ALP. * LAT.</p> <p>2F35 8.85 2.45 TOK-86D NEW</p> <p>TRL-3 NEW</p> <p>TRL-3D NEW</p>

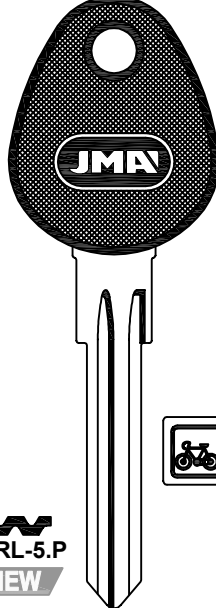
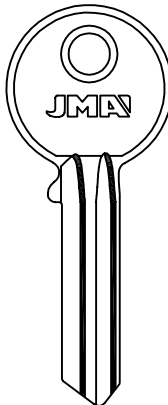
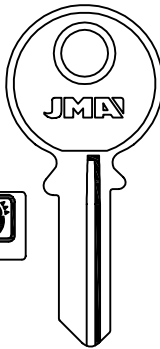
TRELOCK	TRI-CIRCLE
 <p>TRL-5.P NEW</p>  <p>TRL-6 NEW</p> <p>TRL-6D NEW</p>	 <p>TRI-17 NEW</p> <p>TRI-17D</p>

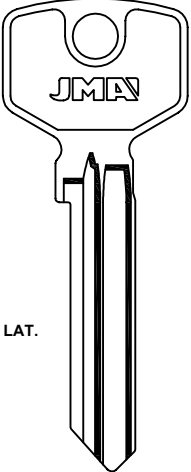
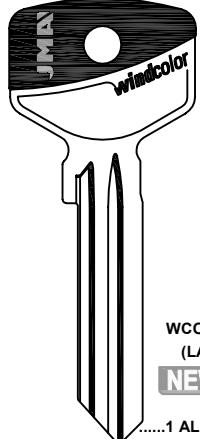
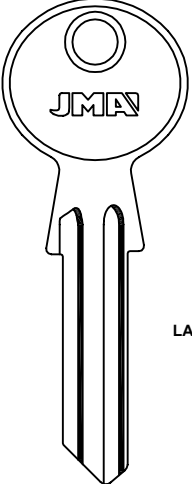
TRIO-VING		
 <p>* LAT.</p> <p>TV-17</p> <p>TV-17D</p> <p>TV-18D</p> <p>TV-19D</p> <p>TV-20</p> <p>TV-21</p> <p>TV-22</p> <p>TV-22D</p> <p>TV-23</p> <p>TV-23D</p>	 <p>windcolor</p> <p>WCOLOR (LAT.) NEW</p> <p>.....1 AL 9 0 AL 9 ...30000-56769 1-26770</p> <p>TV-3D</p> <p>TV-39 NEW</p> <p>TV-36 NEW</p> <p>TV-35 NEW</p> <p>TV-34 NEW</p> <p>TV-32</p> <p>TV-31</p> <p>TV-30</p>	 <p>LAT.</p> <p>TV-37 NEW</p>



TRIO-VING

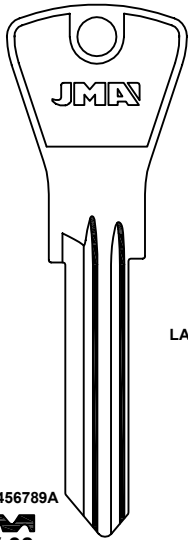

LAT.

123456789A



TV-38

NEW

JOLI SAFE

UCEM

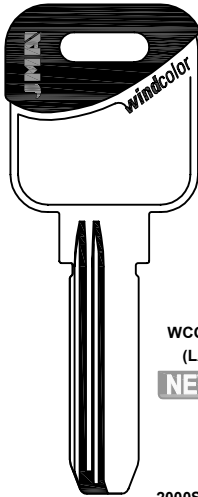

WCOLOR
(LAT.)

NEW

2000S



UCEM-8D

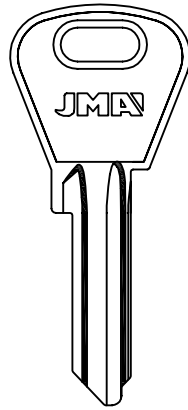

UCEM-19

NEW

TITAN

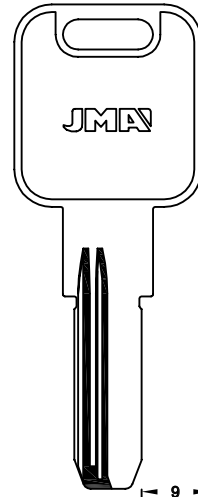

LAT.

2.4 9



UCEM-20D

NEW

PARA-FOR:

TRIO-VING (N)

UCEM (E)

UNIVERSAL

VACHETTE (F)

YALE (D-GB-USA)

UNIVERSAL

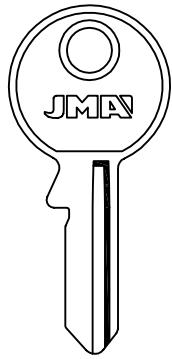

TX-12

NEW

FLOK

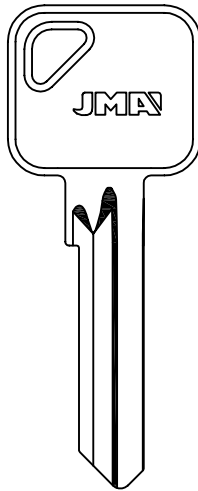

TX-13D

NEW

EURO SPEC

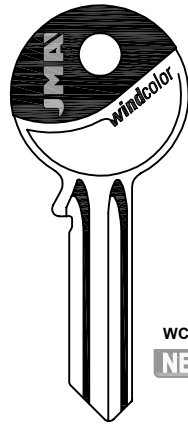

WCOLOR
NEW



U-5I



U-5D

ESAFE-SIL

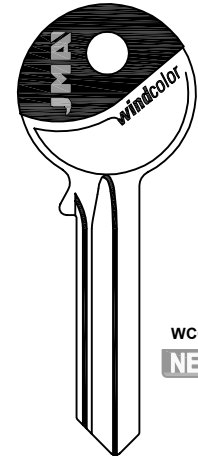

WCOLOR
NEW



U-6D

UNIVERSAL

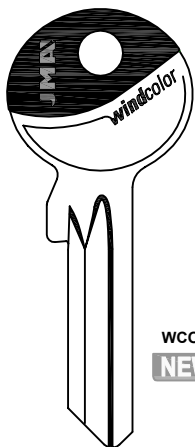

WCOLOR
NEW



U-15D

VACHETTE

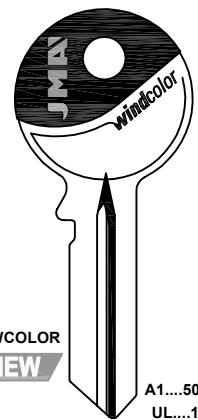

WCOLOR
NEW

A1....5001-5631
UL....1-3500
U....1 AL 9 AL 0



VA-8D



VA-75D

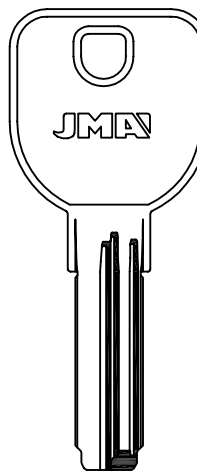

ALP.

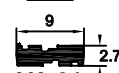

VA-91

NEW

YALE

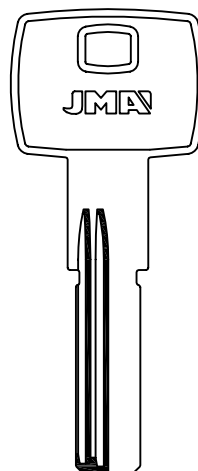

LAT.

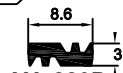

YA-280D

NEW

JMA®

Copyright by Alejandro Altuna S.L.U. 2018



ATENCIÓN: Concerniente a las marcas y denominaciones comerciales ver nota en índice.
ATTENTION: Concerning the marks and commercial denominations see note in index.
ATTENTION: Concernant les marques et dénominations commerciales voir la note dans l'index.
ACHTUNG: Beziehen auf die marke und handelsname sehen sie die notiz im index.

PARA-FOR:

YALE (D-GB-USA)

YARDENI (IL)

YUN HUAN (PRC)

YALE

YARDENI

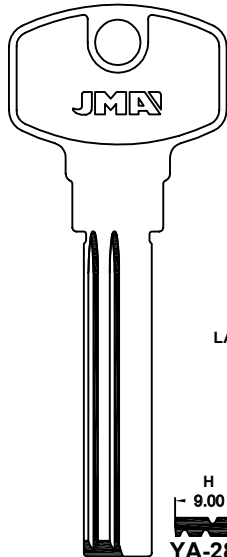

NEW

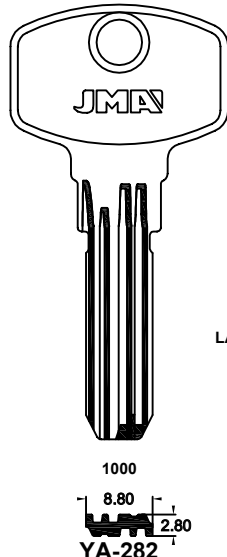

NEW

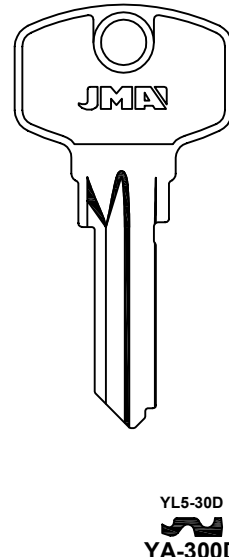

NEW

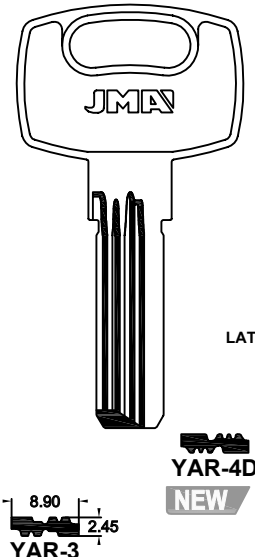

NEW

YUN HUAN

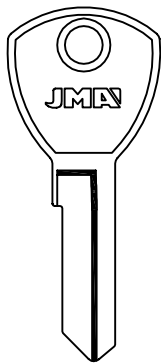

NEW



LLAVES PARA VEHÍCULOS

IBILGAILUENTZAKO GILTZAK

KEYS FOR VEHICLES

CLÉS POUR VÉHICULES

FAHRZAUGESCHLÜSSEL













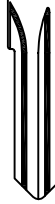

SUPLEMENTO-SUPPLEMENT





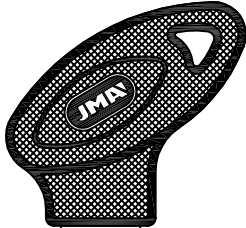



C.11 2018







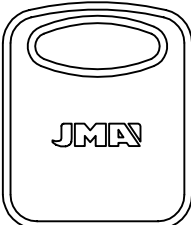

THE KEY TO EXCELLENCE
GLOBALLY UNLOCKING MILLIONS OF DOORS DAILY

PARA-FOR:

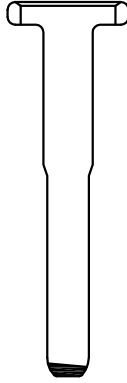
- ABUS (D)
- AXA (S)
- DACIA (R)
- EURO LOCKS (B)
- FORD (USA)
- HUF (D)

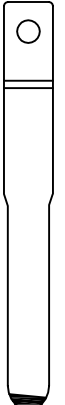
ABUS			AXA
 1-331 X61... X62... V62...  ABU-35.P 1-331 V61... V62...  ABU-36.P BUFFO	  NW52  ABU-87.P NEW	  NW72  ABU-88.P NEW	  LAT.  AX-2.P1  AX-5D.P1 BUFFO NEW

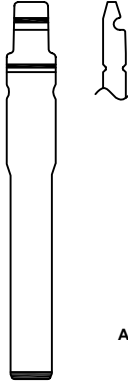
DACIA	EUROLOCKS	
  DAC-4D.P HUF NEW DAC-7DC1 HUF NEW DAC-4DC1 HUF NEW	  LAT.  EU-15.P HOBBY-HYMER NEW 2,9 7,6	  LAT.  EU-16DP HOBBY NEW 2,95 7,2

FORD	HUF		
 LAT.  FO-43D NEW	 ALP.  FO-24C3 NEW1-4000 5.45 3	 ALP.  FO-24C8 NEW1-4000 5.45 3	 ALP.  FO-24C9 NEW1-4000 5.45 3 FORD WITTE



HUF

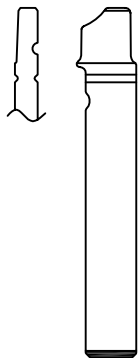

ALP.

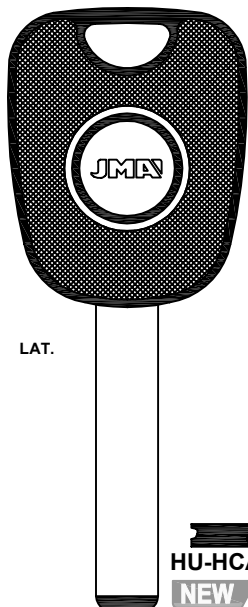

LAT.



ALP.

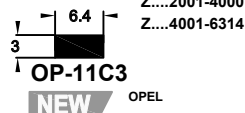

.....0001-3679
Z....1-2000
Z....2001-4000
Z....4001-6314

OPEL

PARA-FOR:

HUF (D)

HYUNDAI (K)

HUF

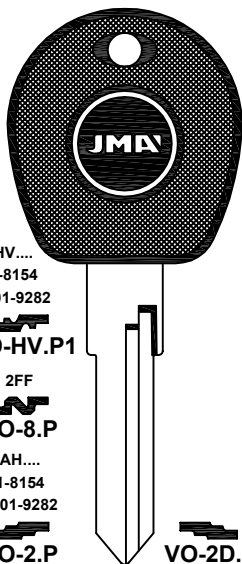

HV....
1-8154
1001-9282

NEW VO-HV.P1

2FF
VO-8.P

AH....
1-8154
1001-9282

VO-2.P

VO-2D.P

VOLKSWAGEN
AKS-CASI-UBE-WITTE

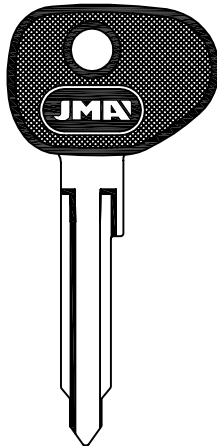

..K..
11-72.1-110

NEW VO-K.P

VOLKSWAGEN
NEIMAN-WITTE

HYUNDAI

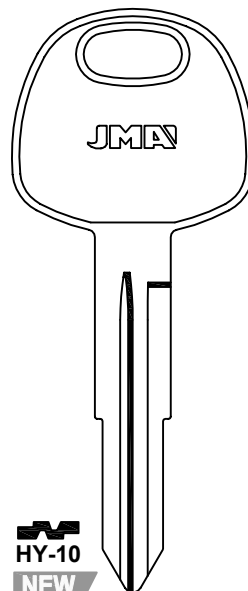

NEW HY-10

HYUNDAI

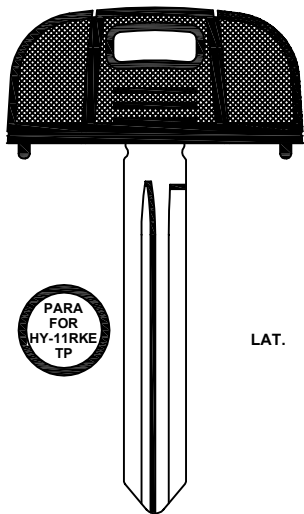

LAT.

PARA FOR HY-11RKE TP

NEW HY-11.P4C1

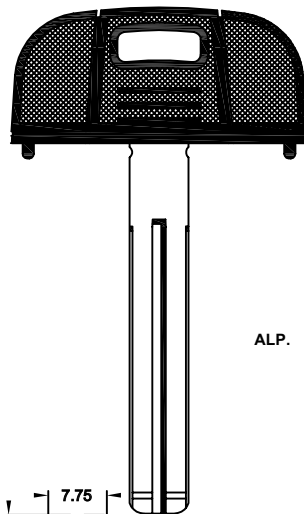

ALP.

7.75
2.95
NEW HY-18P1C1

KIA

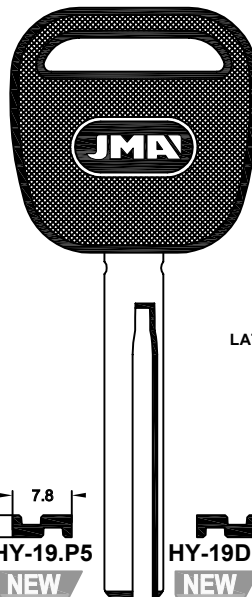

LAT.











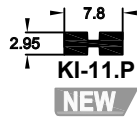

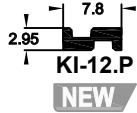

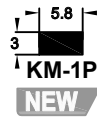
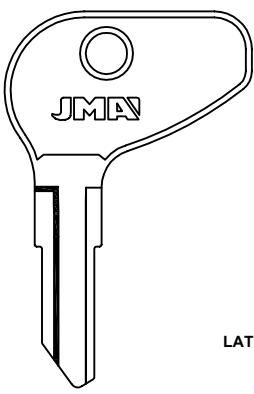

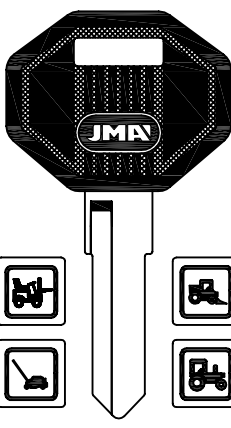

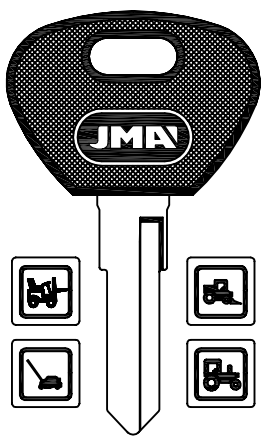
7.8
2.95
NEW HY-19.P5

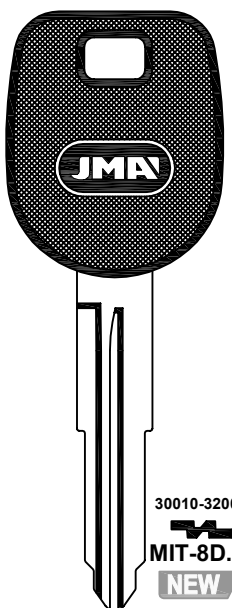
NEW HY-19D.P5

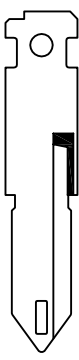

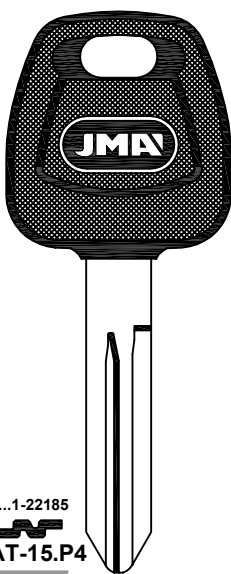
PARA-FOR:

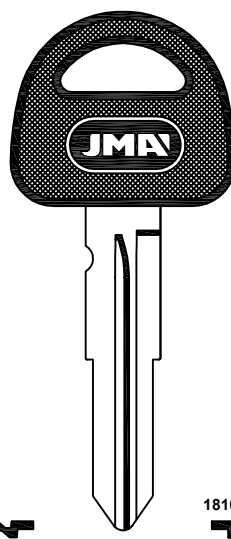
- KIA (K)
- KTM (A)
- KUBOTA (J)
- ERIT-LINDE (D)
- MITSUBISHI (J)
- NEIMAN (F)
- NISSAN (J)
- SUZUKI (J)

KIA		KTM	
 <p>LAT.</p>  <p>KI-11.P NEW</p>	 <p>LAT.</p>  <p>KI-12.P NEW</p>  <p>KI-12D.P NEW</p>	 <p>LAT.</p> <p>... 00001-03001</p>  <p>KM-1P NEW</p>	
KUBOTA	MERIT-LINDE		MITSUBISHI
 <p>LAT.</p>  <p>KUB-2D NEW</p> <p>KUBOTA-MAHINDRA-MITSUBISHI</p>	 <p>LAT.</p>  <p>MERI-1D.P</p>  <p>MERI-2D.P NEW</p>	 <p>LAT.</p>  <p>MERI-1.P1 NEW</p>  <p>MERI-1D.P1 NEW</p>	 <p>LAT.</p> <p>30010-32009</p>  <p>MIT-8D.P2 NEW</p>
NEIMAN	NISSAN	SUZUKI	
 <p>...1/9.... 1/9....A/Z .1/9....A/Z ..1/9....A/Z ...1/9...A/Z1/9..A/Z1/9..A/Z M-N-P-R-S</p>  <p>NE-60C3 NEW</p>	 <p>.....1-22185</p>  <p>DAT-15.P4 NEW</p>	 <p>..... 18100-19229</p>  <p>SUZU-8.P NEW</p> <p>SUZUKI</p>	



SUZUKI



NEW
SUZU-12.P

SUZUKI-KAWASAKI



NEW
SUZU-21.P

.....
6001-7000
SUZU-12D.P

TOYOTA



1....
1-5000
TOYO-15.P

GM-TOYOTA-DAEWOO
TOKAJ-RIKA

NEW
TOYO-15D.P

PARA-FOR:

- SUZUKI (J)
- TOYOTA (J)
- TRELOCK (D)
- VACHETTE (F)
- VALEO (D)
- YAMAHA (J)

TOYOTA

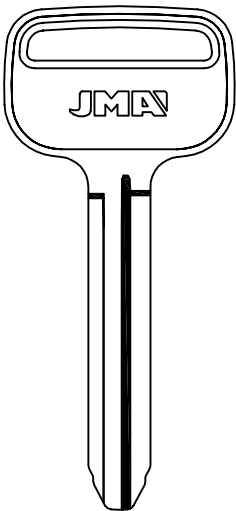

NEW
TOYO-40

TRELOCK

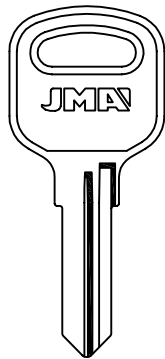

NEW
TRL-3

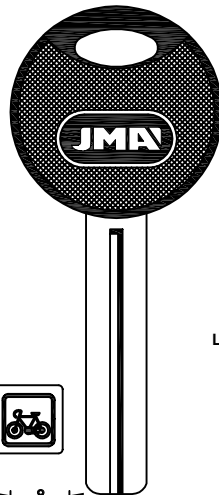

2.95 8
NEW
TRL-4.P

NEW
TRL-3D

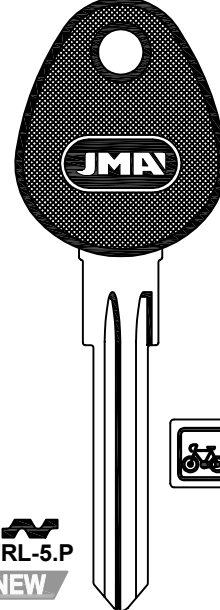

NEW
TRL-5.P

LAT.

VACHETTE



....A/Z 0/9
1-4092
....A/Z 0/9
5001-9092
....A/Z 0/9
1-4092
....A/Z 0/9
5001-9092
NEW
VA-61C3

VALEO



.....1-2-3-4-Q-5-6-7-8-H
.....A-B-C-D-E-F
7
3
NEW
CIT-1C1
CITROEN

ALP.

YAMAHA

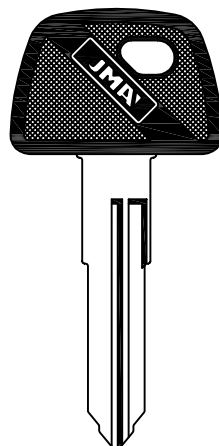

NEW
6001-7000
YAMA-25.P YAMA-25D.P
PUCH-VESPA-YAMAHA

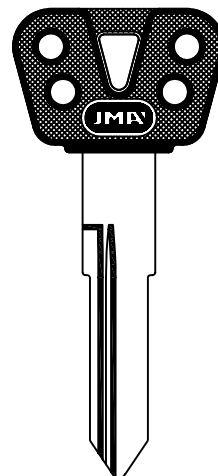

NEW
YAMA-32D.P



PARA-FOR:

YAMAHA (J)

ZADI (I)

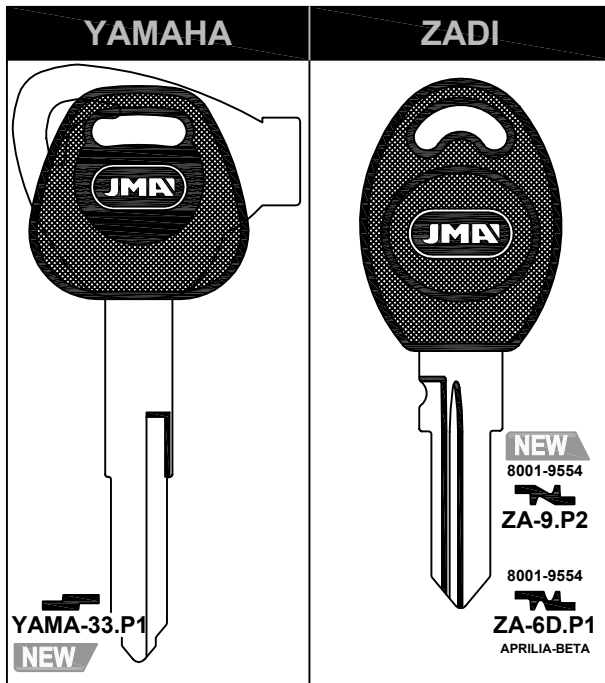

LLAVES DE CRUZ-GORJA-ARMARIO

GURUTZE-GORJA-ARMAIRUETARAKO GILTZA

CRUCIFORM- BIT -FURNITURE KEYS

CLÉS CRUCIFORMES-GORGES- POUR MEUBLES

KREUTZSCHLÜSSEL-CHUBBSCHLÜSSEL-MOBELSCHÜSSEL

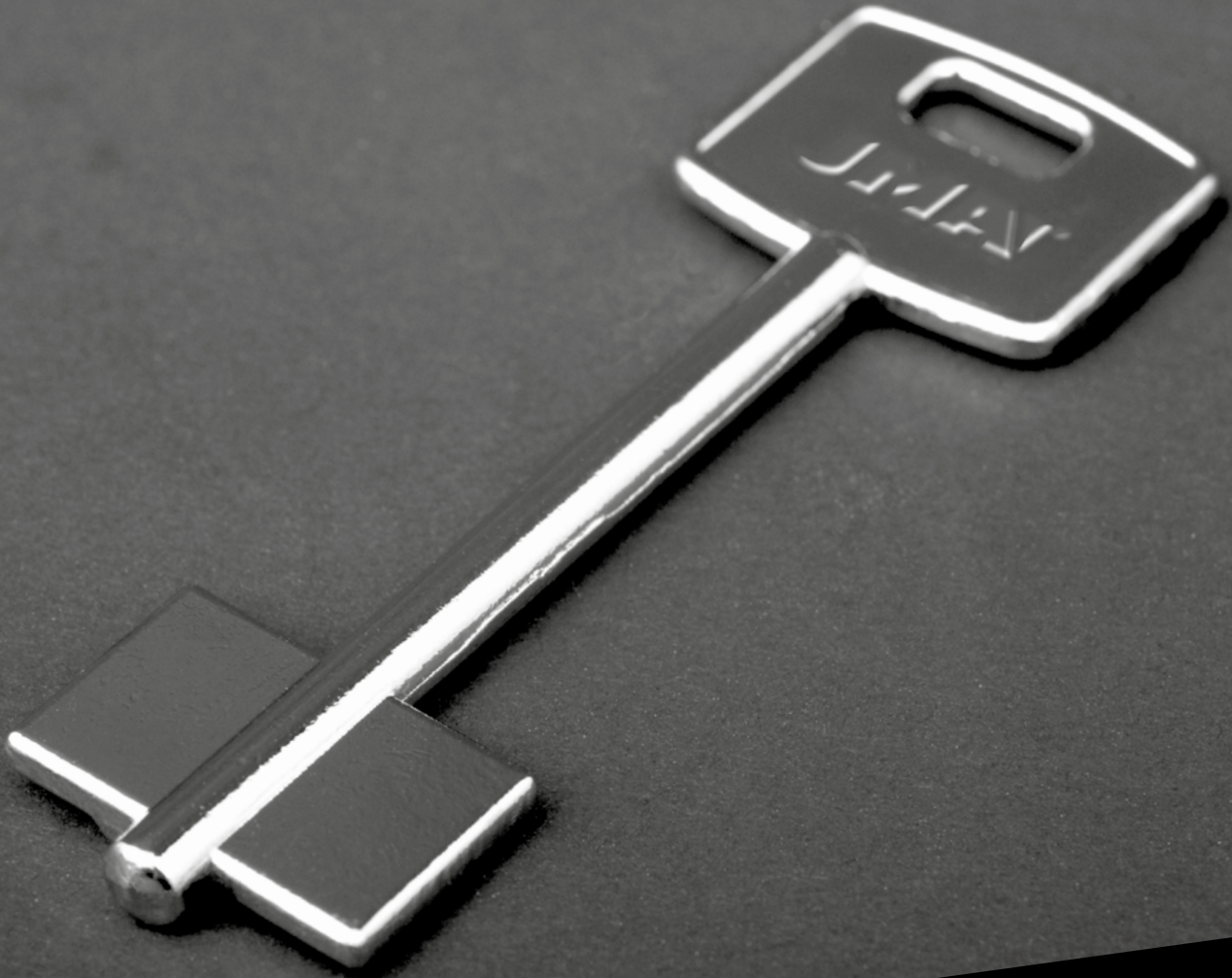

SUPLEMENTO-SUPPLEMENT

C.11 2018

THE KEY TO EXCELLENCE
GLOBALLY UNLOCKING MILLIONS OF DOORS DAILY

PARA-FOR:

101 (P)

716 (P)

BRICARD (F)

CLASS (RUS)

101

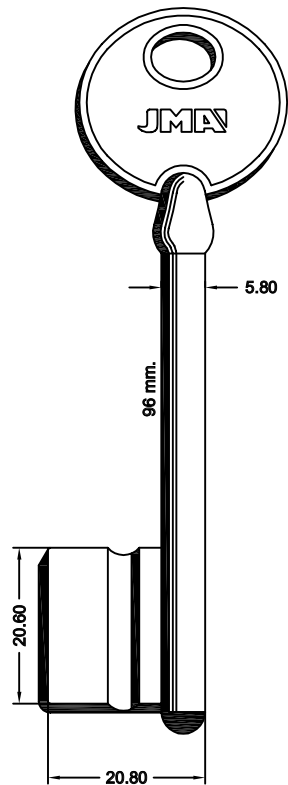

716

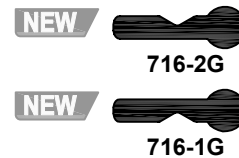
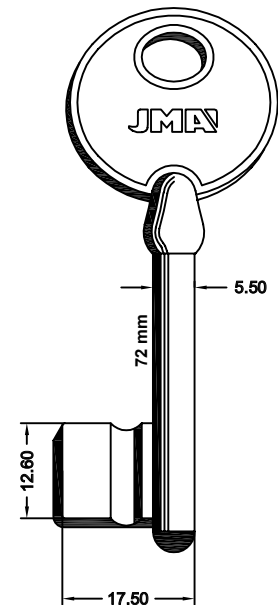

BRICARD

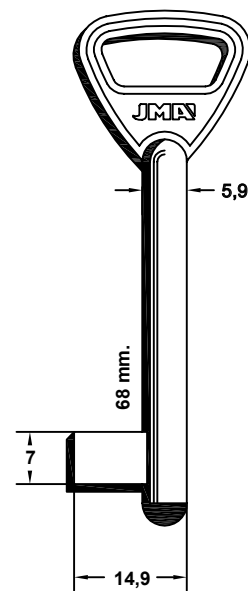
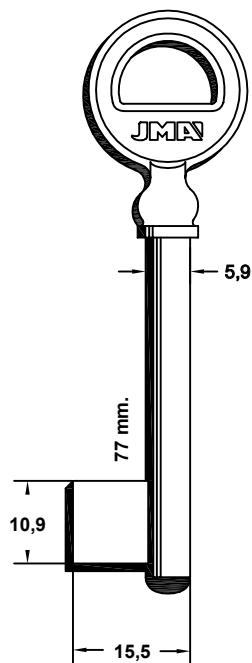
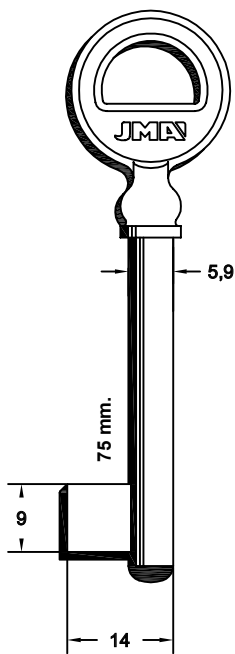

CLASS

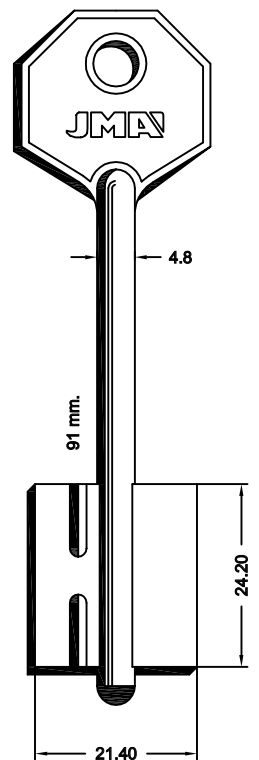

CLASS

DEBEAURAIN-ND

PARA-FOR:

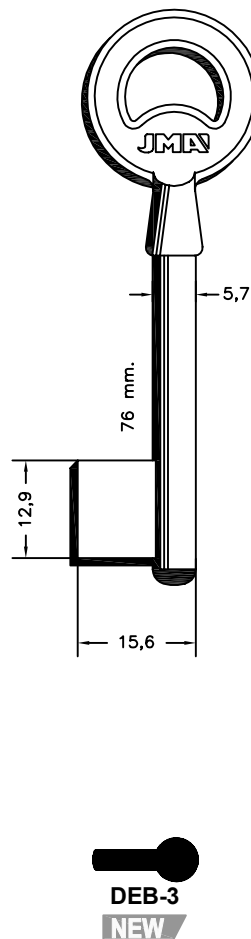
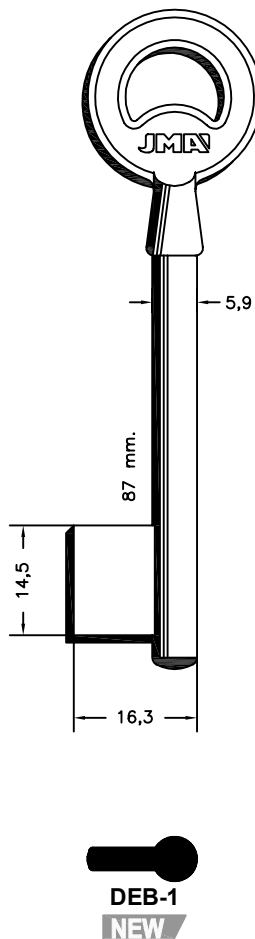
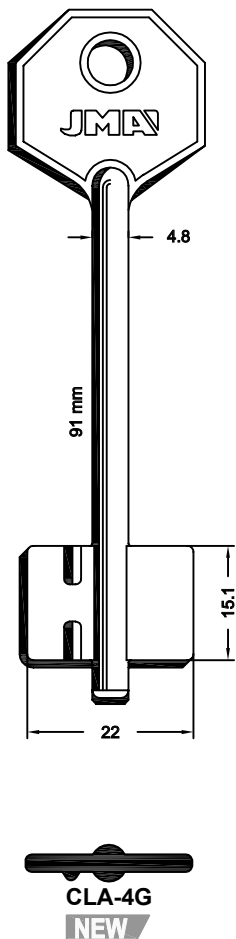
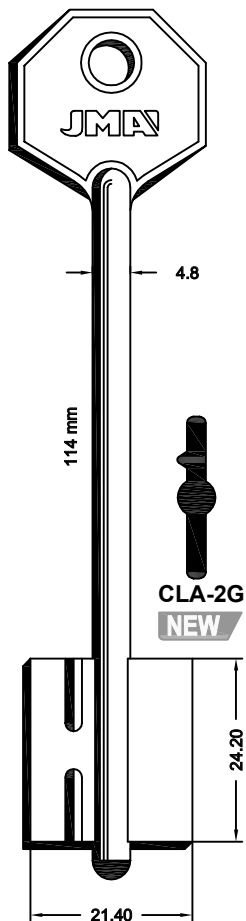

CLASS (RUS)
 DEBEAURAIN ND (F)
 DENY (F)
 ELBOR (RUS)
 EUROSPEC (GB)

DENY

ELBOR

EUROSPEC

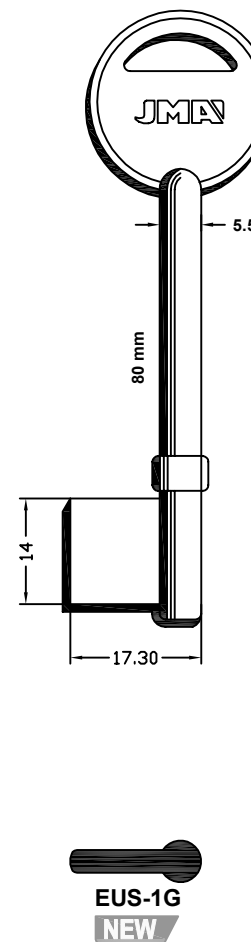
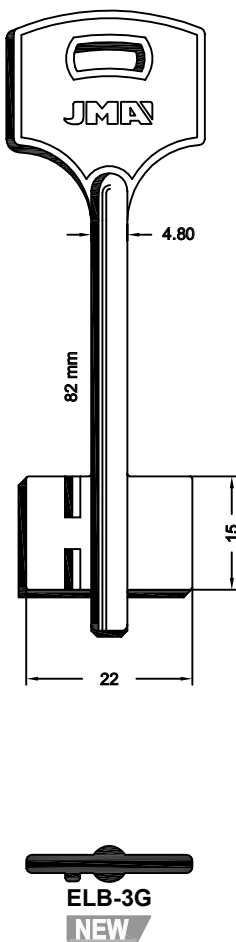
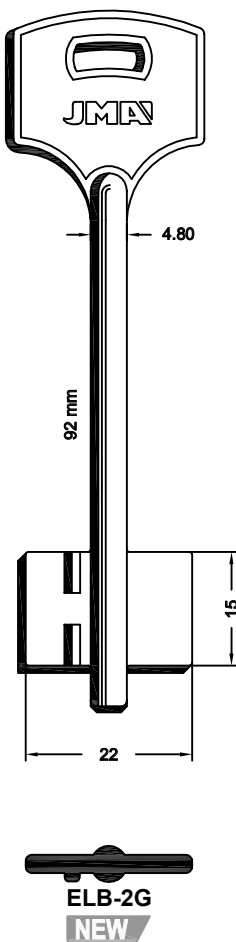
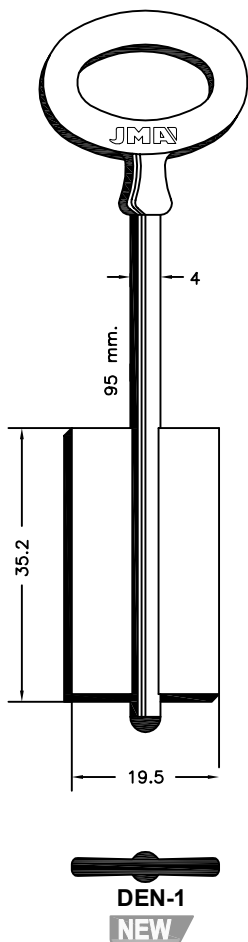

PARA-FOR:

- FICHET (F)
- GARDIAN (RUS)
- GERION (RUS)
- JPM (F)

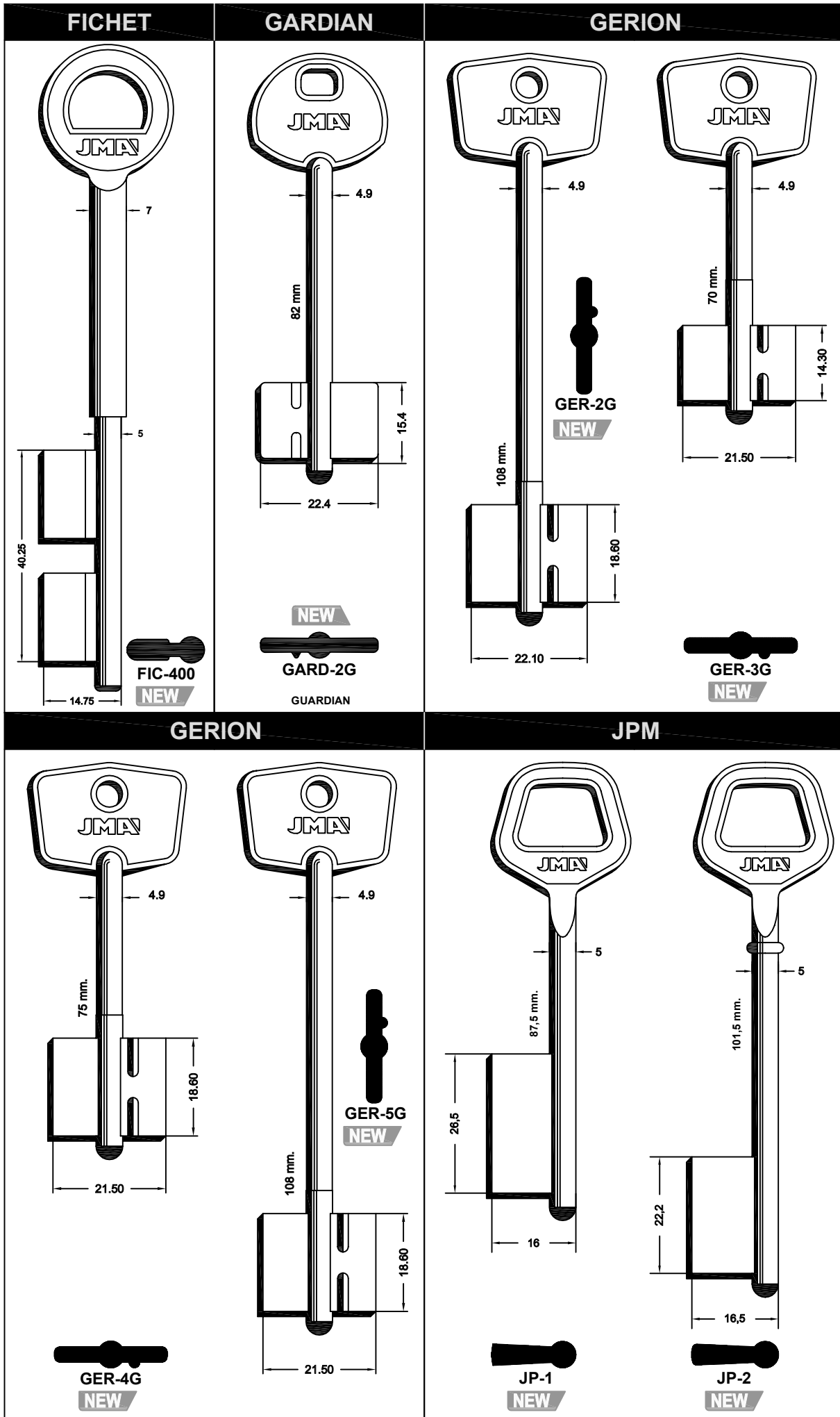

JPM

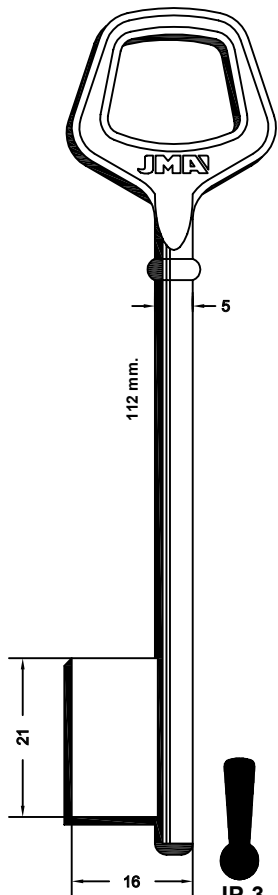

JP-3
NEW

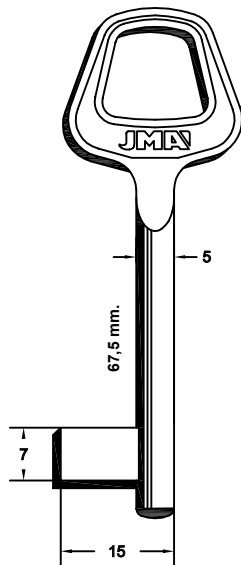

JP-4
NEW

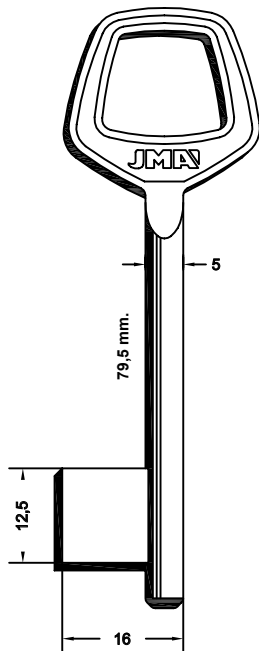

JP-5
NEW

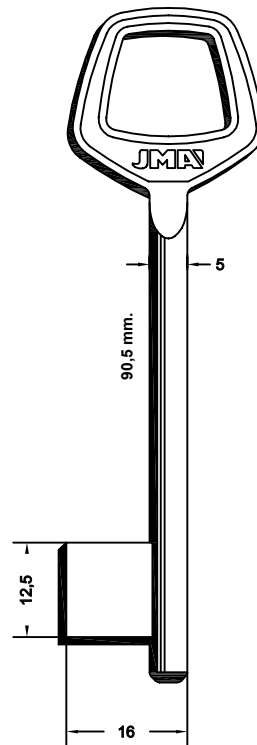

JP-6
NEW

PARA-FOR:

- JPM (F)
- LAPERCHE (F)
- MAFOR (F)
- MOIA (I)

LAPERCHE

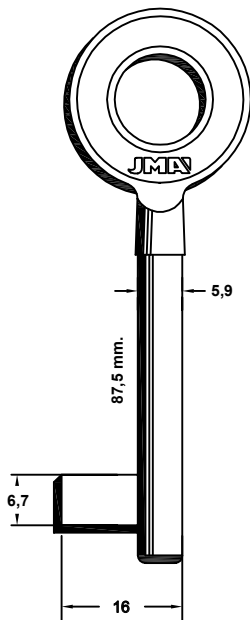

LAP-3
NEW

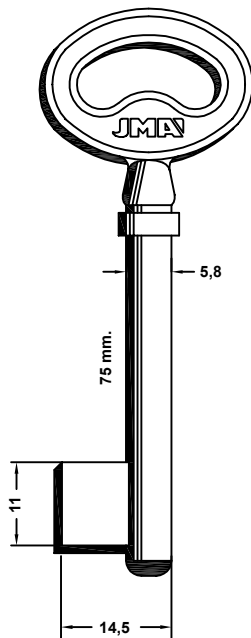

LAP-100
NEW

MAFOR

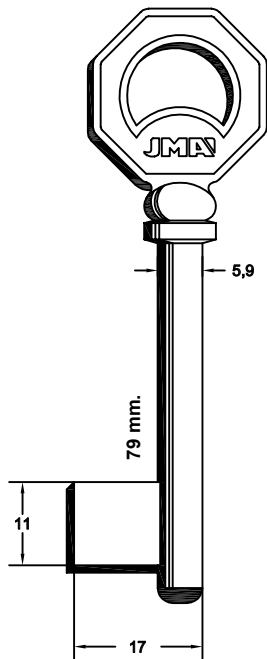

MAF-1
NEW

MOIA

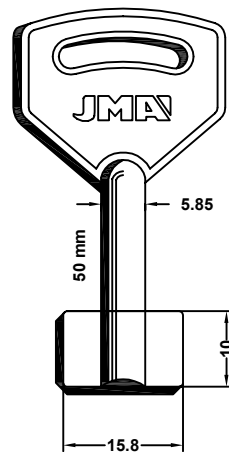

MOI-4G
NEW
O.M.R.







PARA-FOR:

MOIA (I)



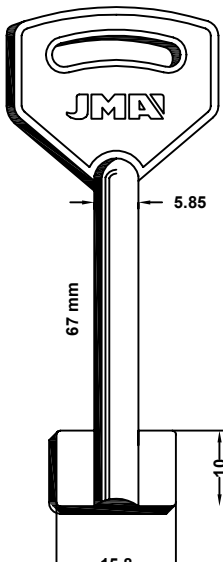
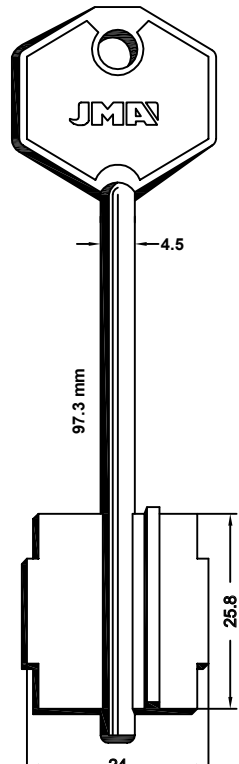
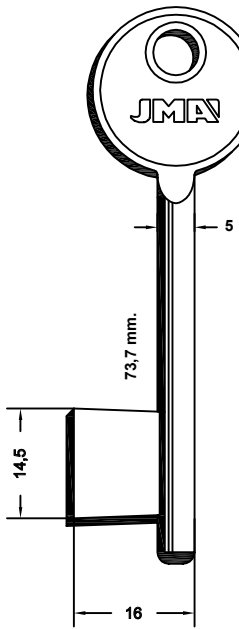
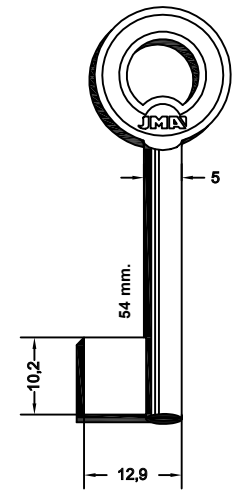

POTENT (I)

SELECT (F)

VACHETTE (F)

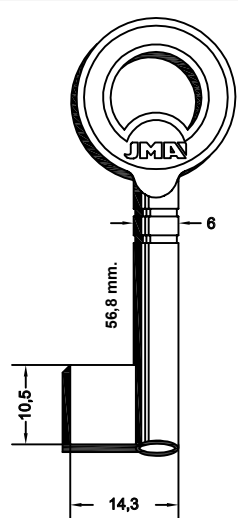
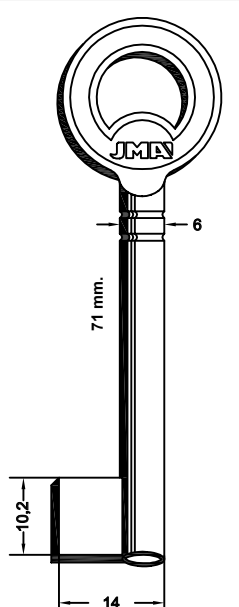
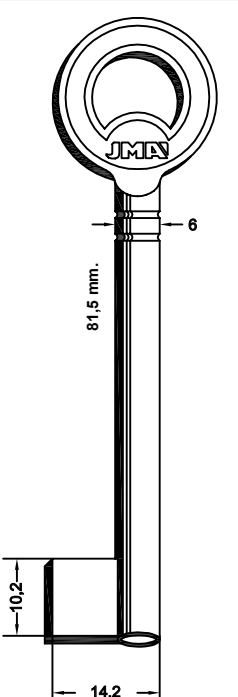
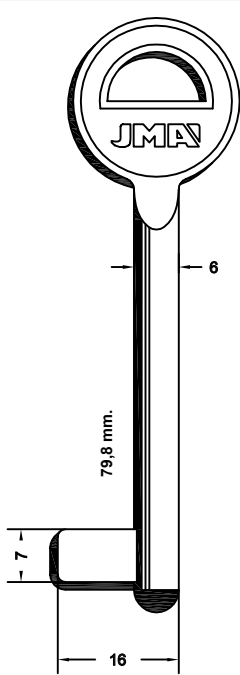
MOIA	POTENT	SELECT	VACHETTE
 <p>67 mm 5.85 15.8 10</p>	 <p>97.3 mm 4.5 24 25.8</p>	 <p>73.7 mm. 5 14.5 16</p>	 <p>54 mm. 5 10.2 12.9</p>
 MOI-5G O.M.R.	 PTN-12G NEW	 SEL-1 NEW	 VA-1T NEW

VACHETTE

 <p>56.8 mm. 6 10.5 14.3</p>	 <p>71 mm. 6 10.2 14</p>	 <p>81.5 mm. 6 10.2 14.2</p>	 <p>79.8 mm. 6 7 16</p>
 VA-2T NEW	 VA-3T NEW	 VA-5T NEW	 VA-400 NEW



VACHETTE

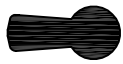
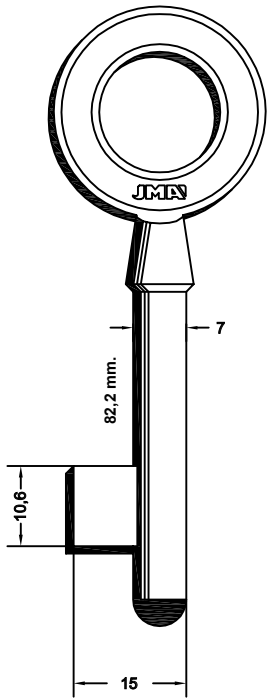

VA-700

NEW

PARA-FOR:
VACHETTE (F)





ESPECIALISTA
SPECIALIST

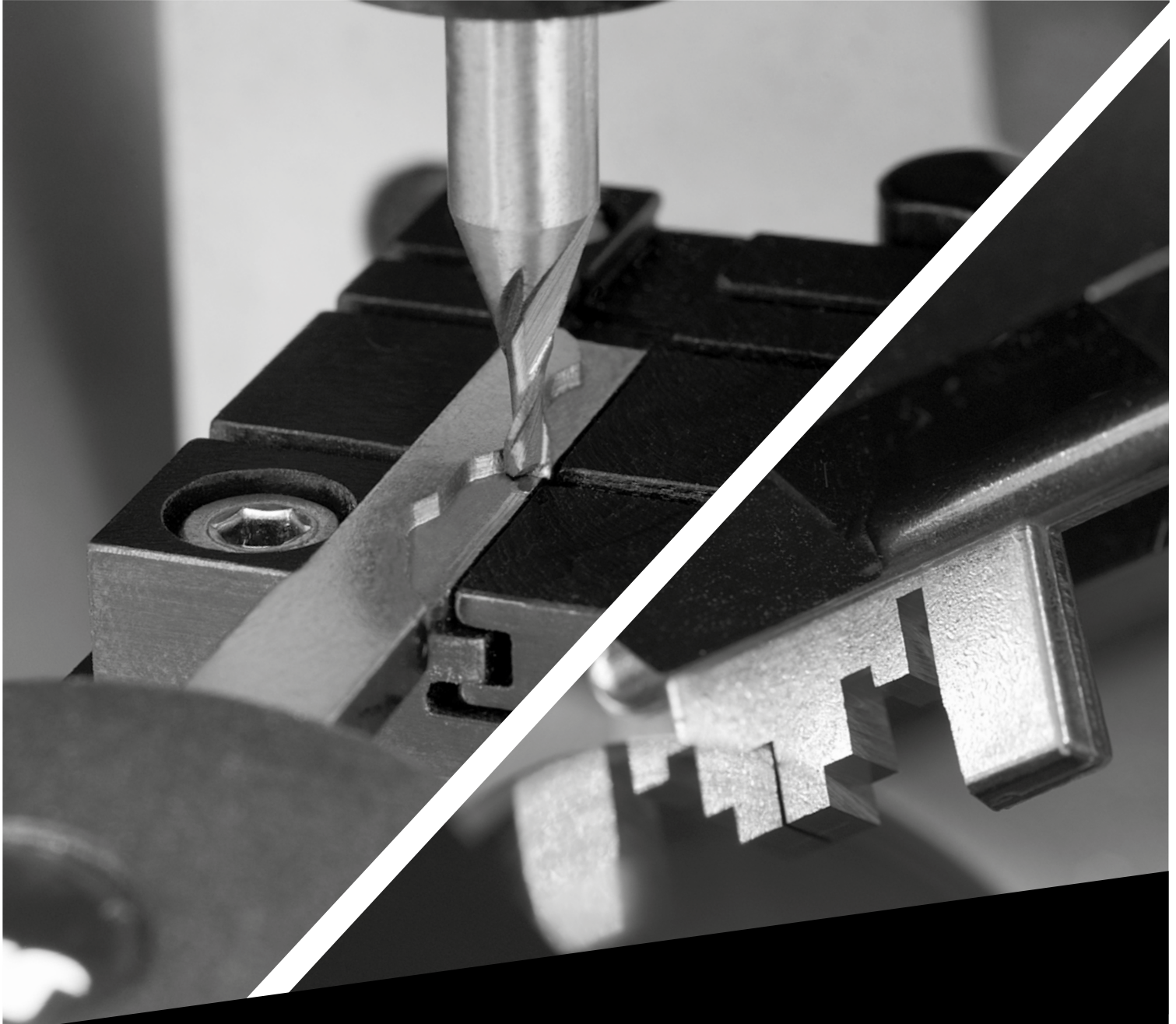

SUPLEMENTO-SUPPLEMENT
C.11 2018

THE KEY TO EXCELLENCE
GLOBALLY UNLOCKING MILLIONS OF DOORS DAILY

MAQUINAS - MACHINES



CAPRI



CAPRISMART



NEO



MULTICODE



X-CODE

FRESAS - CUTTERS

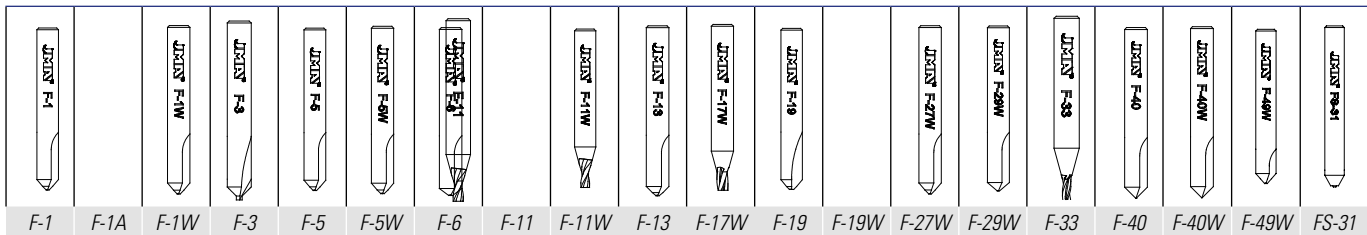

F-1 F-1A F-1W F-3 F-5 F-5W F-6 F-11 F-11W F-13 F-17W F-19 F-19W F-27W F-29W F-33 F-40 F-40W F-49W FS-31

FRESAS - CUTTERS

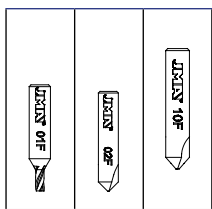

1F 2F 10F

PALPADORES-TRACERS

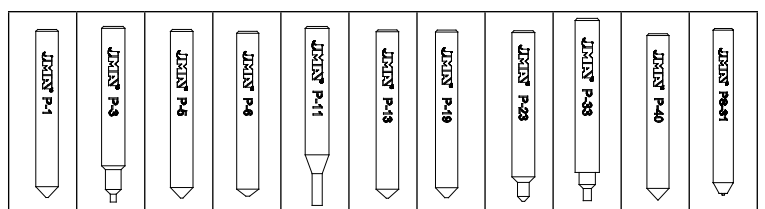

P-1 P-3 P-5 P-6 P-11 P-13 P-19 P-23 P-33 P-40 PS-31

ADAPTADORES - ADAPTORS

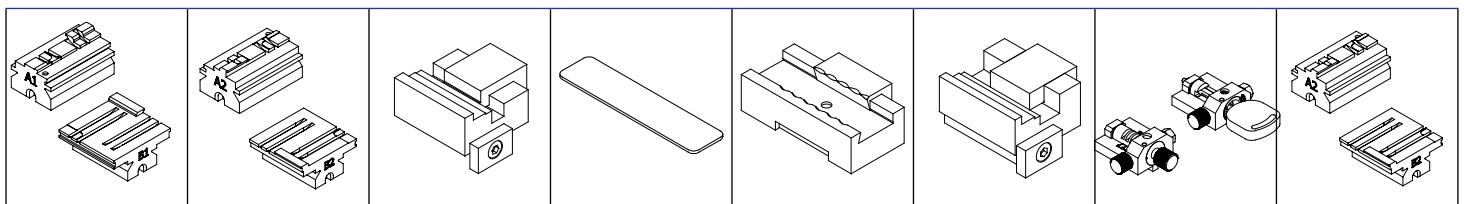

A1-B1 A2-B2 AD-B6 AD-BR AD-CI AD-VAX AD-FO C1-D1



ABUS	ABU-91	CAPRI	F-1	P-1	AD-CI
		CAPRI S.	F-1	P-1	AD-CI
		NEO-DAKKI	F-1	P-1	AD-CI
	ABU-96	CAPRI	F-1	P-1	AD-CI
		CAPRI S.	F-1	P-1	AD-CI
		NEO-DAKKI	F-1	P-1	AD-CI
	ORIGINAL BRAVUS	CAPRI	F-40	P-40	AD-BR
		CAPRI S.	F-40	P-40	AD-BR
		NEO-DAKKI	F-40	P-40	AD-BR
XCODE		F-40W		AD-BR	
AGA	AGA-55D	CAPRI	F-1	P-1	
		CAPRI S.	F-1	P-1	
		NEO-DAKKI	F-1	P-1	
AMIG	AMG-11	CAPRI	F-5	P-5	
		CAPRI S.	F-5	P-5	
		NEO-DAKKI	F-5	P-5	
AXA	AX-5DP1	CAPRI	F-33	P-33	
		CAPRI S.	F-33	P-33	
		NEO-DAKKI	F-33	P-33	
		XCODE	F-33		
	AX-6	CAPRI	F-1	P-23	
		CAPRI S.	F-1	P-23	
BRISANT	BRN-1D	CAPRI	F-1	P-1	
		CAPRI S.	F-1	P-1	
		NEO-DAKKI	F-1	P-1	
BRISANT	BRN-2D	NEO-DAKKI	F-19	P-19	
		CAPRI	F-19	P-19	
		CAPRI S.	F-19	P-19	
		XCODE	F-19W		
		MULTICODE	2F		A1-B1
CISA	CI-48	CAPRI	F-1	P-1	AD-CI
		CAPRI S.	F-1	P-1	AD-CI
		NEO-DAKKI	F-1	P-1	AD-CI
	CI-48P	CAPRI	F-1	P-1	AD-CI
		CAPRI S.	F-1	P-1	AD-CI
		NEO-DAKKI	F-1	P-1	AD-CI
	CI-71	CAPRI	F-1	P-1	AD-CI
		CAPRI S.	F-1	P-1	AD-CI
		NEO-DAKKI	F-1	P-1	AD-CI
	CI-71P	CAPRI	F-1	P-1	AD-CI
		CAPRI S.	F-1	P-1	AD-CI



CI-72	CI-72	NEO-DAKKI	F-1	P-1	AD-CI
		CAPRI	F-1	P-1	AD-CI
		CAPRI S.	F-1	P-1	AD-CI
	CI-72P	NEO-DAKKI	F-1	P-1	AD-CI
		CAPRI	F-1	P-1	AD-CI
		CAPRI S.	F-1	P-1	AD-CI
	CI-73	NEO-DAKKI	F-1	P-1	AD-CI
		CAPRI	F-1	P-1	AD-CI
		CAPRI S.	F-1	P-1	AD-CI
	CI-73P	NEO-DAKKI	F-1	P-1	AD-CI
		CAPRI	F-1	P-1	AD-CI
		CAPRI S.	F-1	P-1	AD-CI
	CI-75P	NEO-DAKKI	F-1	P-1	AD-CI
		CAPRI	F-1	P-1	AD-CI
		CAPRI S.	F-1	P-1	AD-CI
	CI-76P	NEO-DAKKI	F-1	P-1	AD-CI
		CAPRI	F-1	P-1	AD-CI
		CAPRI S.	F-1	P-1	AD-CI
CI-77P	NEO-DAKKI	F-1	P-1	AD-CI	
	CAPRI	F-1	P-1	AD-CI	
	CAPRI S.	F-1	P-1	AD-CI	
CI-78P	NEO-DAKKI	F-1	P-1	AD-CI	
	CAPRI	F-1	P-1	AD-CI	
	CAPRI S.	F-1	P-1	AD-CI	
CI-79P	NEO-DAKKI	F-1	P-1	AD-CI	
	CAPRI	F-1	P-1	AD-CI	
	CAPRI S.	F-1	P-1	AD-CI	
CI-80P	NEO-DAKKI	F-1	P-1	AD-CI	
	CAPRI	F-1	P-1	AD-CI	
	CAPRI S.	F-1	P-1	AD-CI	
CI-81	NEO-DAKKI	F-1	P-1	AD-CI	
	CAPRI	F-1	P-1	AD-CI	
	CAPRI S.	F-1	P-1	AD-CI	
CI-81P	NEO-DAKKI	F-1	P-1	AD-CI	
	CAPRI	F-1	P-1	AD-CI	
	CAPRI S.	F-1	P-1	AD-CI	
CI-82P	NEO-DAKKI	F-1	P-1	AD-CI	
	CAPRI	F-1	P-1	AD-CI	
	CAPRI S.	F-1	P-1	AD-CI	
CI-83P	NEO-DAKKI	F-1	P-1	AD-CI	
	CAPRI	F-1	P-1	AD-CI	
	CAPRI S.	F-1	P-1	AD-CI	



		XCODE	F-1W	AD-X03	
		MULTICODE	2F	C1-D1	
	CI-84P	CAPRI	F-1	P-1	
		CAPRI S.	F-1	P-1	
		NEO-DAKKI	F-1	P-1	
		XCODE	F-1W	AD-X03	
		MULTICODE	2F	C1-D1	
DEKABA	DEK-16	CAPRI	F-1	P-1	
		CAPRI S.	F-1	P-1	
		NEO-DAKKI	F-1	P-1	
	DEK-17	CAPRI	F-6	P-6	
		CAPRI S.	F-6	P-6	
		NEO-DAKKI	F-6	P-6	
DIERRE	DR-2D	CAPRI	F-13	P-13	
		CAPRI S.	F-13	P-13	
		NEO-DAKKI	F-13	P-13	
DOM	DOM-B1	CAPRI	F-1	P-1	
		CAPRI S.	F-1	P-1	
		NEO-DAKKI	F-1	P-1	
	DOM-B2	CAPRI	F-1	P-1	
		CAPRI S.	F-1	P-1	
		NEO-DAKKI	F-1	P-1	
	DOM-B6	CAPRI	F-1A	P-23	AD-B6
		CAPRI S.	F-1A	P-23	AD-B6
		NEO-DAKKI	F-1A	P-23	AD-B6
ELZETT	ELZ-13	CAPRI	F-5	P-5	
		NEO-DAKKI	F-5	P-5	
		CAPRI S.	F-5	P-5	
EUROLOCKS	EU-15P	CAPRI	F-33	P-33	
		NEO-DAKKI	F-33	P-33	
		CAPRI S.	F-33	P-33	
	EU-16DP	CAPRI	F-33	P-33	
		CAPRI S.	F-33	P-33	
		NEO-DAKKI	F-33	P-33	
FERONERIA	FER-2D	CAPRI	F-19	P-19	
		CAPRI S.	F-19	P-19	
		NEO-DAKKI	F-19	P-19	
F-CV	FV-3	CAPRI	F-5	P-5	
		CAPRI S.	F-5	P-5	
		NEO-DAKKI	F-5	P-5	
HOK	HOK-1D	CAPRI	F-5	P-5	
		CAPRI S.	F-5	P-5	
		NEO-DAKKI	F-5	P-5	



HUF	HU-4C1	CAPRI	F-11	P-11	
		CAPRI S.	F-11	P-11	
		NEO-DAKKI	F-11	P-11	
HUF	FO-24C3	CAPRI	F-11	P-11	
		CAPRI S.	F-11	P-11	
		NEO-DAKKI	F-11	P-11	AD-F024
		XCODE	F-11W		
		MULTICODE	1F		A1-B1
HUF	FO-24C8	CAPRI	F-11	P-11	
		CAPRI S.	F-11	P-11	
		NEO-DAKKI	F-11	P-11	AD-F024
		XCODE	F-11W		
		MULTICODE	1F		A1-B1
HUF	FO-24C9	CAPRI	F-11	P-11	
		CAPRI S.	F-11	P-11	
		NEO-DAKKI	F-11	P-11	AD-F024
		XCODE	F-11W		
		MULTICODE	1F		A1-B1
HUF	HU-HCAP	CAPRI	F-11	P-11	
		CAPRI S.	F-11	P-11	
		NEO-DAKKI	F-11	P-11	
		XCODE	F-17W		
		MULTICODE	1F		A2-B2
HUF	OP-11C3	CAPRI	F-11	P-11	
		CAPRI S.	F-11	P-11	
		NEO-DAKKI	F-11	P-11	
		XCODE	F-17W		
		MULTICODE	1F		A1-B1
HYUNDAI	HY-19P5	CAPRI	F-11	P-11	
		CAPRI S.	F-11	P-11	
		NEO-DAKKI	F-11	P-11	
HYUNDAI	HY-19DP5	CAPRI	F-11	P-11	
		CAPRI S.	F-11	P-11	
		NEO-DAKKI	F-11	P-11	
HYUNDAI	HY-18P1C1	CAPRI	F-11	P-11	
		CAPRI S.	F-11	P-11	
		NEO-DAKKI	F-11	P-11	
ITO	ITO-3D	CAPRI	F-1	P-1	
		CAPRI S.	F-1	P-1	
		NEO-DAKKI	F-1	P-1	
KESO	KE-6	CAPRI	F-1	P-1	
			FS-31	PS-31	
		CAPRI S.	F-1	P-1	



			FS-31	PS-31
		NEO-DAKKI	F-1	P-1
			FS-31	PS-31
		X-CODE	F-49W	
		MULTICODE	10F	
KIA	KI-11P	CAPRI	F-11	P-11
		CAPRI S.	F-11	P-11
		NEO-DAKKI	F-11	P-11
	KI-12P	CAPRI	F-11	P-11
		CAPRI S.	F-11	P-11
		NEO-DAKKI	F-11	P-11
	KI-12DP	CAPRI	F-11	P-11
		CAPRI S.	F-11	P-11
		NEO-DAKKI	F-11	P-11
KTM	KM-1P	CAPRI	F-11	P-11
		CAPRI S.	F-11	P-11
		NEO-DAKKI	F-11	P-11
		X-CODE	F-11W	
		MULTICODE	1F	
LINCE	LIN-26D	CAPRI	F-5	P-5
		CAPRI S.	F-5	P-5
		NEO-DAKKI	F-5	P-5
		XCODE	F-5W	
MAUER	MAU-1	CAPRI	F-1	P-1
		CAPRI S.	F-1	P-1
		NEO-DAKKI	F-1	P-1
	MAU-2	CAPRI	F-1	P-1
		CAPRI S.	F-1	P-1
		NEO-DAKKI	F-1	P-1
MCM	MCM-15E8	CAPRI	F-1	P-1
		CAPRI S.	F-1	P-1
		NEO-DAKKI	F-1	P-1
MHA	MH-1	CAPRI	F-5	P-5
		CAPRI S.	F-5	P-5
		NEO-DAKKI	F-5	P-5
MLM	MLM-8	CAPRI	F-3	P-3
		CAPRI S.	F-3	P-3
		NEO-DAKKI	F-3	P-3
MOTTURA	MT-2D	CAPRI	F-5	P-5
		CAPRI S.	F-5	P-5
		NEO-DAKKI	F-5	P-5
	MT-1P	CAPRI	F-1	P-1
		CAPRI S.	F-1	P-1



		NEO-DAKKI	F-1	P-1
		XCODE	F-27W	
OJMAR	OJ-20/4	CAPRI	F-1	P-1
		CAPRI S.	F-1	P-1
		NEO-DAKKI	F-1	P-1
		XCODE	F-29W	
OMEC	OMC-3	CAPRI	F-1	P-1
		CAPRI S.	F-1	P-1
		NEO-DAKKI	F-1	P-1
	OMC-7	CAPRI	F-1	P-1
		CAPRI S.	F-1	P-1
		NEO-DAKKI	F-1	P-1
POTENT	PTN-2D	CAPRI	F-19	P-19
		CAPRI S.	F-19	P-19
		NEO-DAKKI	F-19	P-19
	PTN-3D	CAPRI	F-19	P-19
		CAPRI S.	F-19	P-19
		NEO-DAKKI	F-19	P-19
PREFER	PR-21	CAPRI	F-5	P-5
		CAPRI S.	F-5	P-5
		NEO-DAKKI	F-5	P-5
	PR-22	CAPRI	F-5	P-5
		CAPRI S.	F-5	P-5
		NEO-DAKKI	F-5	P-5
SEA	SEA-2	CAPRI	F-1	P-1
		CAPRI	F-3	P-3
		CAPRI S.	F-1	P-1
		CAPRI S.	F-3	P-3
		NEO-DAKKI	F-1	P-1
		NEO-DAKKI	F-3	P-3
TECON	TC-3	CAPRI	F-5	P-5
		CAPRI S.	F-5	P-5
		NEO-DAKKI	F-5	P-5
TESA	TE-T80EH	CAPRI	F-5	P-5
		CAPRI S.	F-5	P-5
		NEO-DAKKI	F-5	P-5
		XCODE	F-5W	
TOVER	TOV-4	CAPRI	F-1	P-1
		CAPRI S.	F-1	P-1
		NEO-DAKKI	F-1	P-1
		XCODE	F-1W	
TRELOCK	TRL-4P	CAPRI	F-11	P-11



		<i>CAPRI S.</i>	<i>F-11</i>	<i>P-11</i>	
		<i>NEO-DAKKI</i>	<i>F-11</i>	<i>P-11</i>	
UCEM	<i>UCEM-20D</i>	<i>CAPRI</i>	<i>F-6</i>	<i>P-6</i>	
		<i>CAPRI S.</i>	<i>F-6</i>	<i>P-6</i>	
		<i>NEO-DAKKI</i>	<i>F-6</i>	<i>P-6</i>	
		<i>XCODE</i>	<i>F-6</i>		
VACHETTE	<i>VA-91</i>	<i>CAPRI</i>	<i>F-1</i>	<i>P-1</i>	
		<i>CAPRI S.</i>	<i>F-1</i>	<i>P-1</i>	
		<i>NEO-DAKKI</i>	<i>F-1</i>	<i>P-1</i>	
VALEO	<i>CIT-1C1</i>	<i>CAPRI</i>	<i>F-11</i>	<i>P-11</i>	<i>AD-VAX</i>
		<i>CAPRI S.</i>	<i>F-11</i>	<i>P-11</i>	
		<i>NEO-DAKKI</i>	<i>F-11</i>	<i>P-11</i>	
		<i>XCODE</i>	<i>F-17W</i>		
		<i>MULTICODE</i>	<i>1F</i>		<i>A1-B1</i>
YALE	<i>YA-281D</i>	<i>CAPRI</i>	<i>F-5</i>	<i>P-5</i>	
		<i>CAPRI S.</i>	<i>F-5</i>	<i>P-5</i>	
		<i>NEO-DAKKI</i>	<i>F-5</i>	<i>P-5</i>	
	<i>YA-280D</i>	<i>CAPRI</i>	<i>F-5</i>	<i>P-5</i>	
		<i>CAPRI S.</i>	<i>F-5</i>	<i>P-5</i>	
		<i>NEO-DAKKI</i>	<i>F-5</i>	<i>P-5</i>	
YALE	<i>YA-282</i>	<i>CAPRI</i>	<i>F-5</i>	<i>P-5</i>	
		<i>CAPRI S.</i>	<i>F-5</i>	<i>P-5</i>	
		<i>NEO-DAKKI</i>	<i>F-5</i>	<i>P-5</i>	
		<i>X-CODE</i>	<i>F-19</i>		
		<i>MULTICODE</i>	<i>2F</i>		
YARDENI	<i>YAR-3</i>	<i>CAPRI</i>	<i>F-13</i>	<i>P-13</i>	
		<i>CAPRI S.</i>	<i>F-13</i>	<i>P-13</i>	
		<i>NEO-DAKKI</i>	<i>F-13</i>	<i>P-13</i>	

PLANAS

FLAT

ABLOY	ABL-7	AVANTCODE	FP-27W	AV2	

MÁQUINAS MACHINES

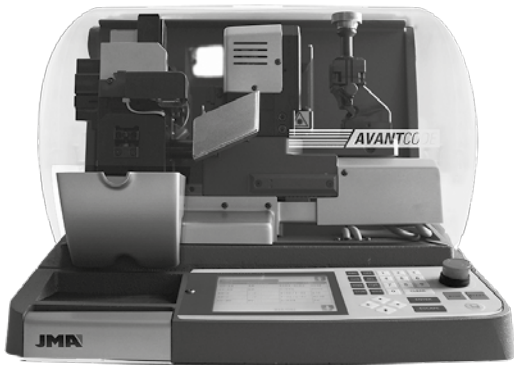

AVANTCODE

FRESAS CUTTERS

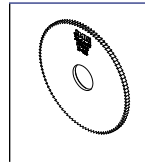

FP-27W

ADAPTADORES ADAPTORS

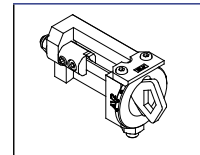

AV2

GORJA

BIT

ABLOY	ABL-7	SARARTOGA	TITAN BIT	EABLOY	ABL-S
DENNY	DEN-1	SENA			AD-DEN

ADAPTADORES ADAPTORS

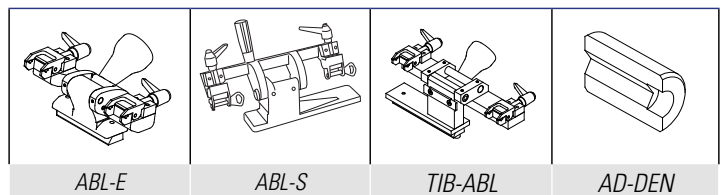

ABL-E

ABL-S

TIB-ABL

AD-DEN

MÁQUINAS MACHINES



SARATOGA

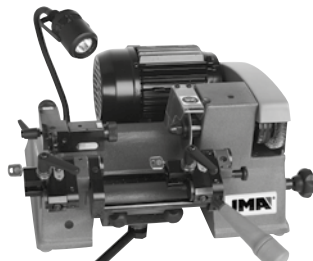

TITAN BIT



ECCO ABLOY



SENA

JMA FRANCE

JMA FRANCE SAS
Tel +33 01 39 22 42 10
Fax +33 01 39 22 42 11
Technoparc
13, rue Edouard Jeanneret
F- 78306 Poissy Cedex
www.jmafrance.fr
service.commercial@jmafrance.fr

JMA POLSKA

JMA POLSKA Sp. z o.o.
Tel +48 42 635 12 80
Fax +48 42 635 12 85
91- 342 Łódź, ul. Zbąszyńska 3
www.jmapolska.pl
biuro@jmapolska.pl

JMA PORTUGAL

ALTUNA PORTUGAL
COMERCIO DE CHAVES UNIPessoal, LDA.
Tel +351 219 947 470
Fax +351 219 947 471
Rua de Goa N°22
2690-356 Santa Iria de Azoia
www.jmaportugal.com
comercial@jmaportugal.com

JMA UK

SKS LTD
Tel +44 144 229 1400
Fax +44 144 286 3683
Unit 2, Canalside Northbridge Road
Berkhamsted
Herts HP4 1EG
www.jmakeys.co.uk
sales@skskeys.co.uk

JMA MAROC

JMA MAROC S.A.R.L.
Tel +0520 150 535
Fax +0520 150 536
83,85 Bd Oued ZIZ, El Oulfa
Casablanca
www.jma.ma
jma@jma.ma

JMA INDIA

JMA KEYS INDIA PVT. LTD
Tel +91 124 428 5450
Fax +91 124 428 5451
H-239 & H-240, Sushant Shopping Arcade
Sushant Lok-1, Block B
122002 Gurgaon (Haryana)
www.jmakeys.in
info@jmakeys.in

JMA MEXICO

LLAVES ALTUNA DE MEXICO S.A de C.V
Tel +52 33 3777 1600
Fax +52 33 3777 1609
Av. Aviación No. 5520
Col. San Juan de Ocotán
C.P. 45019 Zapopan, Jalisco
www.jma.com.mx
ventas@jma.com.mx

JMA PERU

JMA PERU S.A.C.
Tel +51 639 9300
Av. Los Paracas 130,
Urbanización Salamanca,
Distrito Ate, Lima
www.jma-peru.com
info@jma-peru.com

JMA COLOMBIA

IFAM - JMA Colombia, S.A.S.
Tel +57 1 53333246
Fax +57 3203497446
Diagonal 115A - 70B - 45 Local 1
Bogotá
www.jmacolombia.com
info@jmacolombia.com

JMA SPAIN

JMA ALEJANDRO ALTUNA, S.L.U.
Tel +34 943 79 30 00
Fax +34 943 79 72 43
Bidekurtzeta, 6 P.O.Box - Apdo. 70
20500 Arrasate - Mondragón
Gipuzkoa - SPAIN
www.jma.es
jma@jma.es

JMA USA

ALTUNA GROUP USA INC.
Tel +1 817 385 0515
Fax +1 817 385 4850
1513 Greenview Drive
75050 Grand Prairie
Texas
www.jmausa.com
info@jmausa.com

JMA ARGENTINA

JMA ARGENTINA S.A.
Tel +54 336 4 462 422
Fax +54 336 4 462 422
Av. Central Acero Argentino Oeste 678
COMIRSA - 2900 San Nicolas
www.jma.com.ar
info@jma.com.ar

JMA URUGUAY

JMA URUGUAY S.A.
Tel +598 2908 1175
Fax +598 2900 6681
Mercedes 1420
11100 Montevideo
www.jma.com.uy
info@jma.com.uy

JMA WORLDWIDE

ALTUNA GROUP HEADQUARTERS

Tel +34 943 79 30 00
Fax +34 943 79 72 43
Bidekurtzeta, 6 P.O.Box - Apdo. 70
20500 Arrasate - Mondragón
Gipuzkoa - SPAIN
www.altuna.com

